

Installation system

DISCOVER THE
POWER OF
EFFICIENCY AND
CONVENIENCE





ONE SINGLE
SOLUTION
SOLVED IN
ONE GO

11

By selecting timeless colors that are adapted to local habits, you're not only creating a beautiful space, but also making a sustainable investment that will last for years to come. Discover our timeless colours on page 11.



stago®

Content

01	Wibe Group presents Stago installation system.	45	Stago WGX 130/72
03	Stago The story of Stago	49	Stago WGX 165V/52
05	Benefits & features of the Stago installation systems.	55	Stago WGX 170/65
11	Color	59	Stago WGX 170A/65
13	Aluminium trunking The perfect blend of high-performance and sustainability.	65	Stago WGX 170/72 asymmetric
15	Stago WGX-A 110/55	71	Stago WGX 183/72
19	Stago WGX-A 120/72	75	Stago WGX 233/72
29	Steel trunking Strong and versatile, built to last.	93	Sustainability Sustainable solutions for generations to come.
31	Stago WGX 110/52	95	Dedicated wiring device Smart design, built for ease of use.
35	Stago WGX 110/72	97	Stago WGX-W
39	Stago WGX 120/65		

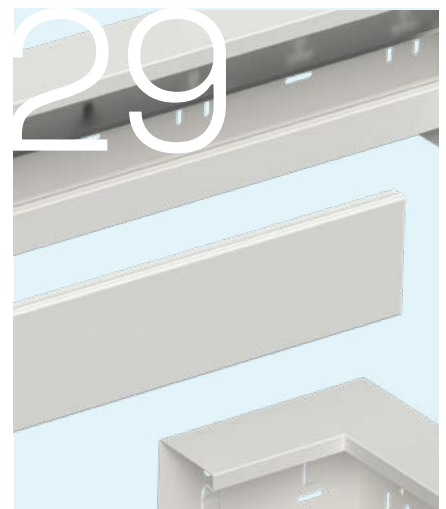
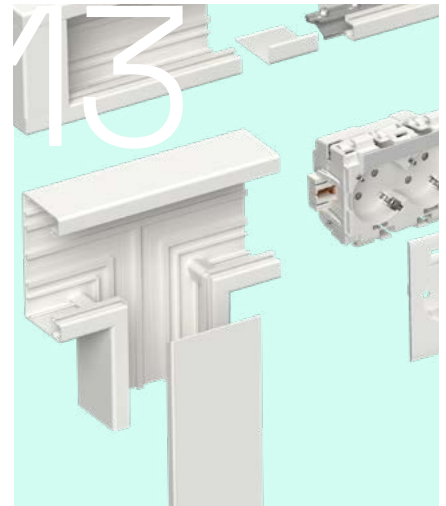

Wibe Group presents – Stago Installation system

Welcome into our new catalogue with aluminium, steel, and dedicated wiring devices to help you create installations with ease. Browse our selection and discover the power of efficiency and convenience.

Let's say hello, to one single solution, reimagined and engineered from the ground up, where cable management can be solved in one go. One streamlined system that allows for easy planning, easy procurement and easy installation.

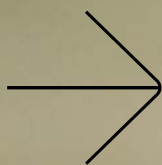
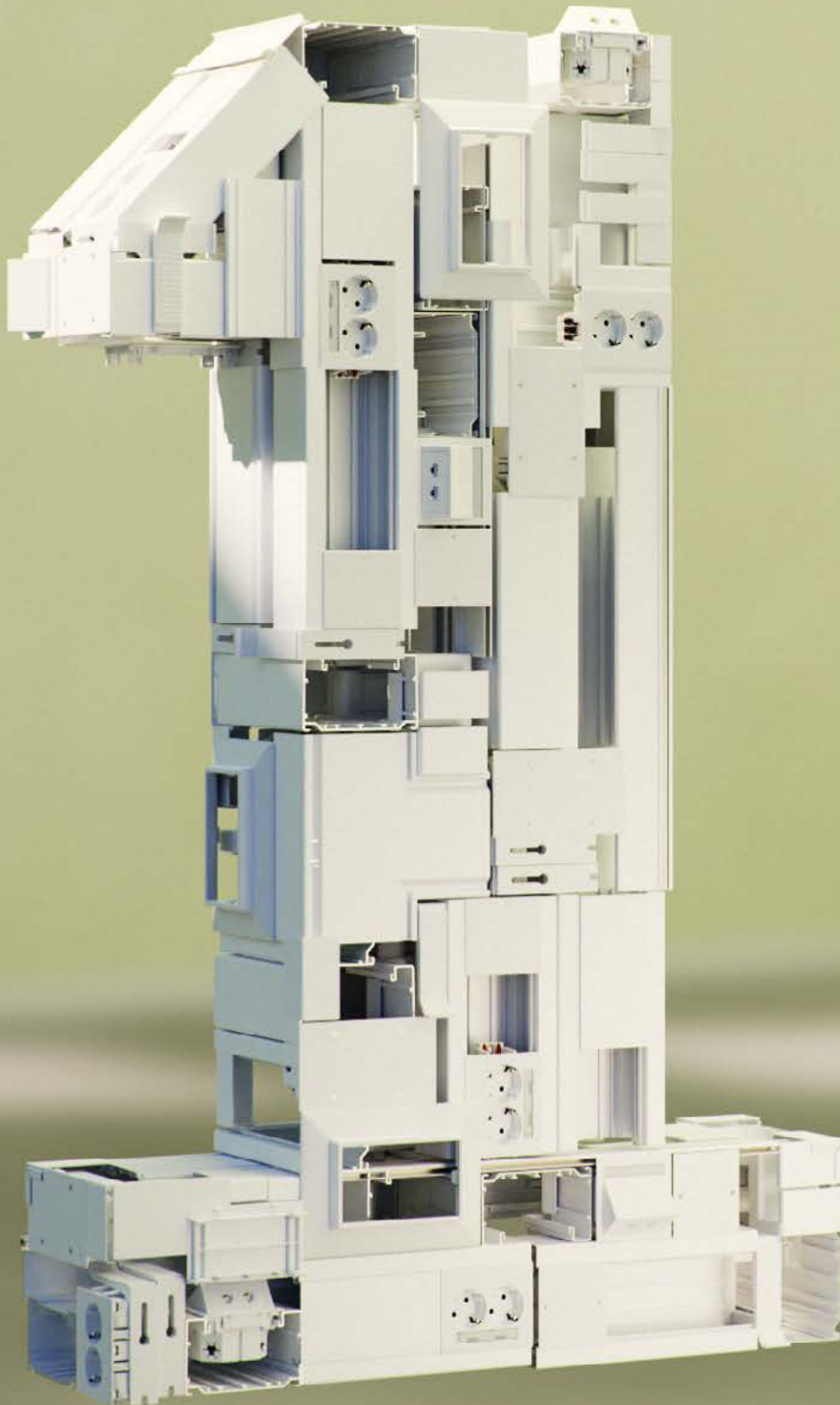

One solution where all parts fit together.
One system, engineered from the ground up.
One provider, moving the industry forward.
One with nature, an environmentally conscious choice.

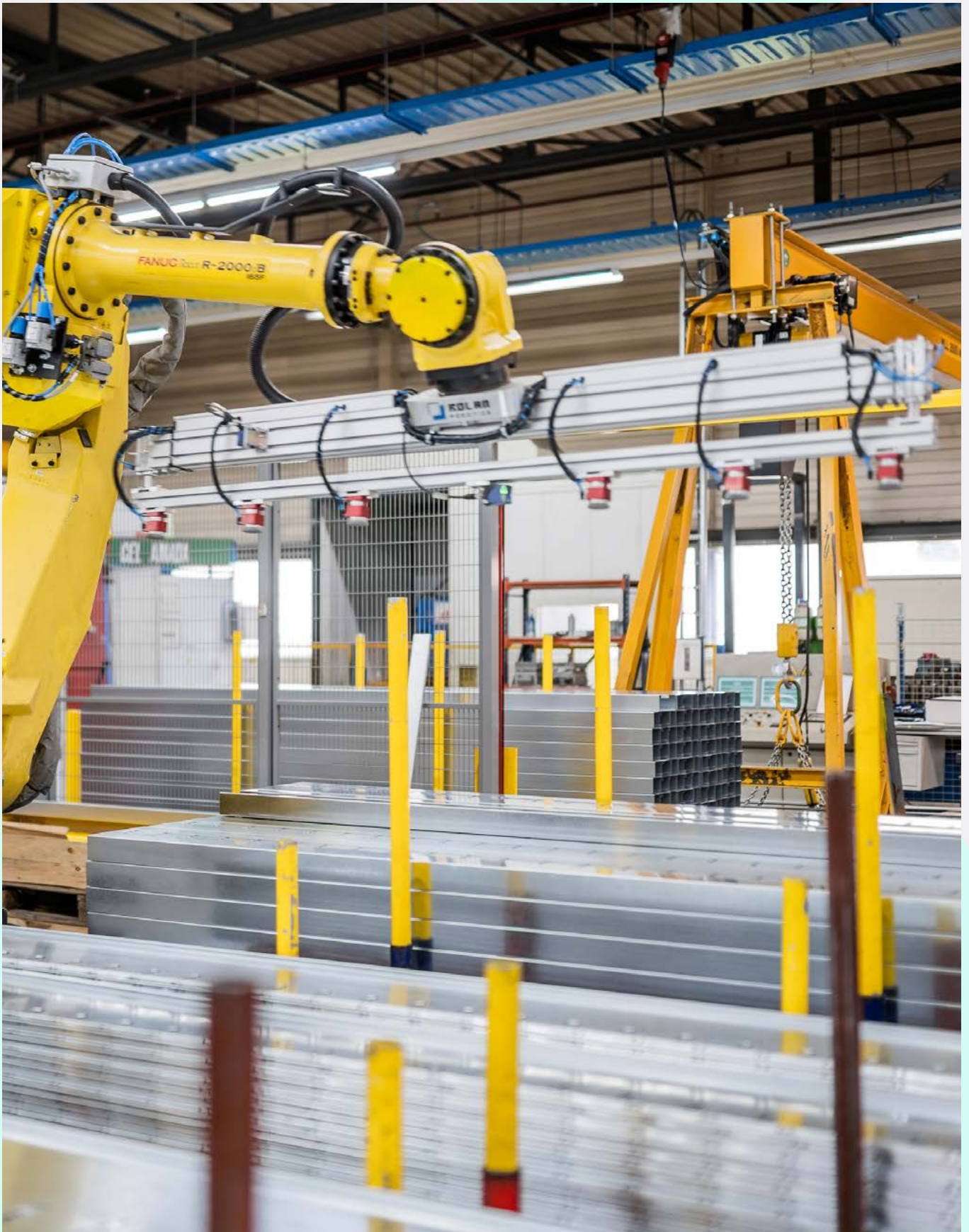

Curiosity meets innovation: Stago's uplifting solutions

Decades of expertise and close collaboration together with customers have made us a trusted partner in the industry.

Since our founding in the Netherlands in 1945, by the entrepreneurs, Tot and Beers which saw an opportunity to redevelop worn-out electrical equipment from the war, Stago has been driven by a passion for innovation, a curiosity for our customers needs, and an commitment to quality. With our developing, manufacturing, and delivering cable management systems, we continue to grow and provide top-quality solutions for our customers. Today, Stago is one of four brands within the Wibe Group, renowned for our innovative and high-quality cable management systems.

Customer collaboration is our priority - our team of experts are always here to give you friendly support at all times.

Stago Installation Systems

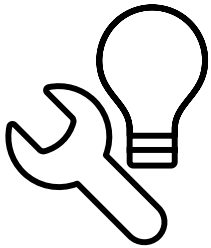

Easy to install

Our entire system has been designed with ease of use and ease of installation in mind. The improved solution adheres to industry standards, making sure that architects and engineers can easily work it into their designs. The click system makes the installation process fast and smooth.

The improved system is designed to fit together in a modern, aesthetic way. In addition, we have developed accessories which make it both forgiving and easy to work with, regardless of prior experience. Each part has been designed for a perfect fit, easy to install and to reconfigure.

We always try to make life easier for our partners. And the world a little more Onederful.

Safe

Our wiring devices have earned the S-mark from Intertek to denote it meets the high safety standards in Europe. It can be used in any commercial building, warehouse, office, school, government building and hospital, as it provides a safe and flexible installation solution for any type of environment.

The socket outlets have been designed to make it impossible to reach the live wires with your fingers, making installation safer. Even if you remove the front cover from the socket outlet the system remains IP20. The wiring devices provide double insulated installation, meaning that no protective earth is required. The aluminium and steel trunking can be connected to functional earth if shielding of electrical fields is required/prescribed.

We hold ourselves to the highest standards of safety. But are always down to earth.

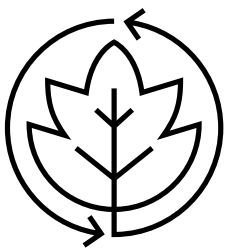

Improved impact on the environment

The entire system has been based upon our sustainable design principles. Minimizing waste, making sure we use as little energy and raw materials as possible, and by prioritizing reuse and modularity. Our aluminium parts are made from recycled aluminium, results in a CO₂ footprint that is 65% lower than the European average produced. And to the extent, if possible, we work with local suppliers and manufacturers to avoid unnecessary transportation.

A system based on our long term commitment to sustainability.

Reliable and experienced

Our new system draws on almost a 100-years of experience in the cable management industry. It has allowed us to create a solution that is easy to add to new and existing floor plans. We have designed a fully integrated system that will be launched over time. Having an optimized number of well-designed and smarter parts means simplifying the procurement, planning and installation process for any building project.

Drawn from experience. Designed for the future. And built on trust.

Quality products

We use the highest grade and most sustainable materials available. Putting our name on a product means that it has gone through rigorous testing and quality checks. And we set the same high standards for all our product offerings. Our products are made to withstand the test of both wear and time. The redesigned – one solution, one system approach – is us making a long-term commitment.

We ensure that spare parts will be made available for maintenance and replacement for as long as needed. Something that speaks to both the quality and sustainability of the efforts we are making. The system was designed from the get-go based upon the sustainable design principle. With total flexibility to be reconfigurable and to be able to accommodate changing needs, without having to change the entire system.

The highest quality through and through. Our way of working, and our promise to you.

Fast service

We pride ourselves on providing the best service possible to our clients, it has been part of the Wibe Group way of doing business since we started almost 100 years ago, and we are convinced that it will never go out of style. We are always just a phone call away – offering accessible, friendly, helpful, and proactive customer service whenever it is needed.

We believe in making timeless products, meaning that they won't run out of stock, or that they'll be gone the day after when you might need to complement your installation. Having our products in stock and readily available means reactive lead times and ease of procurement. We aim to work with local suppliers, to minimize time and cost for transportation and shipping – and to provide more flexibility when offer bespoke solutions.

We make sure that you get what you need, when you need it, for as long as you do.

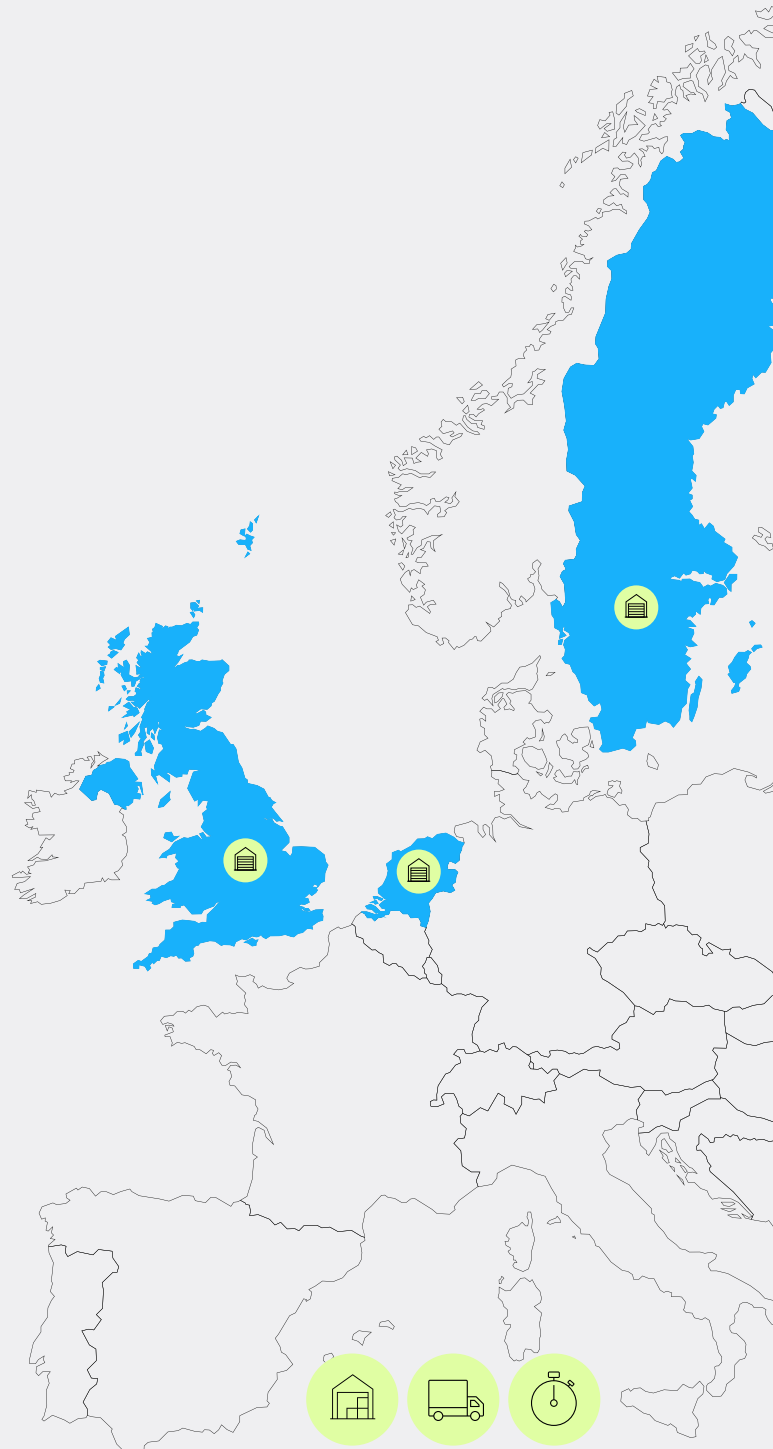

24/7 Stock availability

“

Our long lasting experience together with our customers have given us the skill to simplify a sustainable and clever system









Color selection

Colors that surround us in our everyday life have a meaning that extends beyond mere aesthetics. They influence our experiences, behaviors and performance while helping us navigate our physical environment. Our colors are based on local habits and needs, and they represent our standard offer. By choosing timeless colors adapted to local habits, you get a sustainable investment.



Black RAL 9017



Unpainted





White RAL 9003



White RAL 9010



White RAL 1013



Aluminium trunking – the perfect blend of high-performance and sustainability

If you're looking for an efficient, sustainable installation system, WGX-A aluminium trunking is the perfect fit. With its timeless design, recycled aluminium, and total flexibility to be reconfigurable and to be able to accommodate changing needs, without having to change the entire system, WGX-A stands out in our product range.

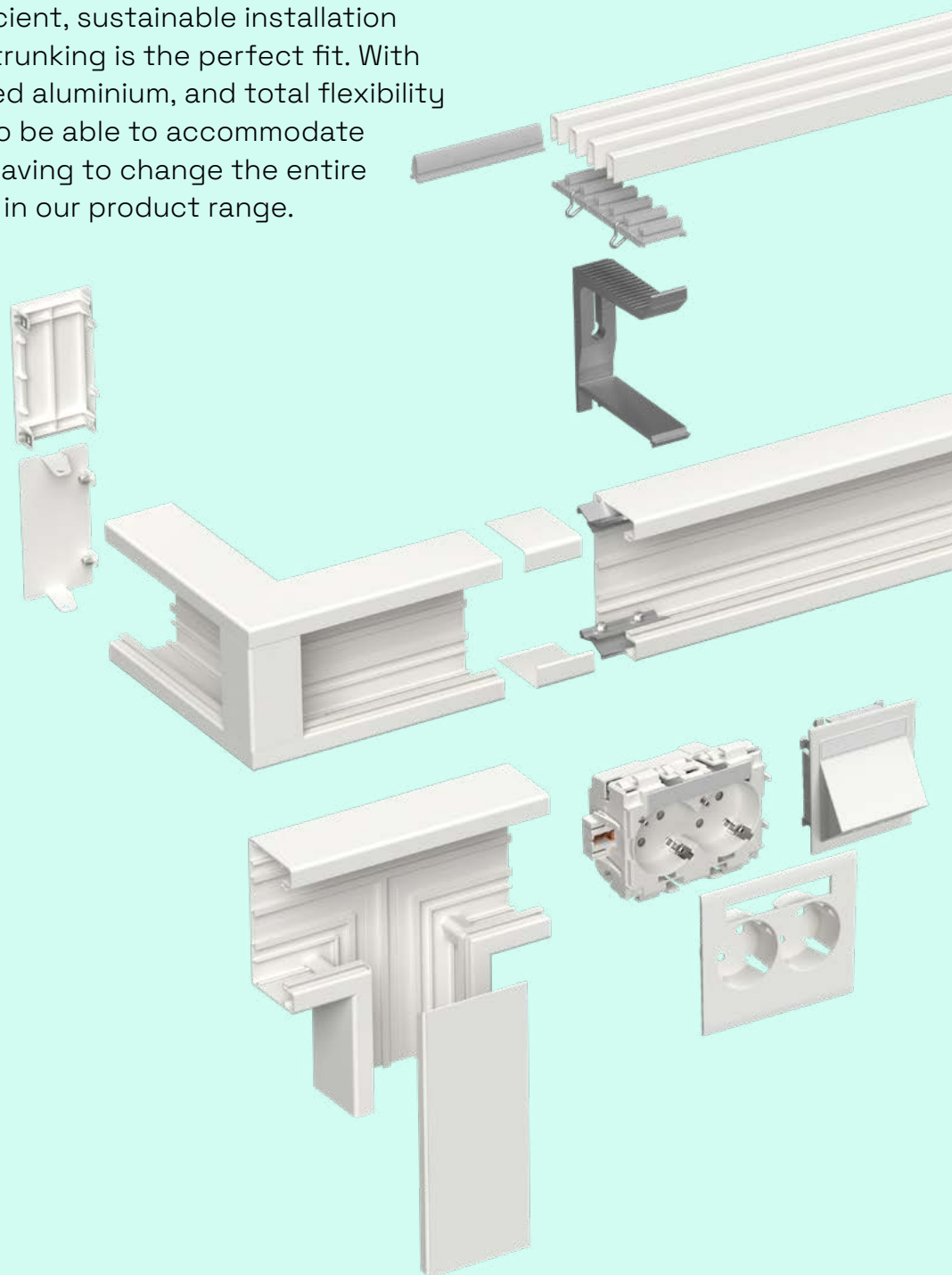

Material: Aluminium

Available dimensions:

→ WGX-A 110/55

→ WGX-A 120/72

Timeless Design

The system is designed to fit together in a modern, aesthetic way. WGX-A trunking offers a sleek look with its aluminium finish, available in two colors - RAL9003 and RAL9017.

Easy to Install

Our entire system has been designed with ease of use and ease of installation in mind. WGX-A trunking offers outstanding flexibility and is designed to accommodate changing needs over time without requiring a complete system overhaul. The system was created based on sustainable design principles, ensuring that spare parts are available for maintenance and replacement for as long as necessary, emphasizing both quality and sustainability.

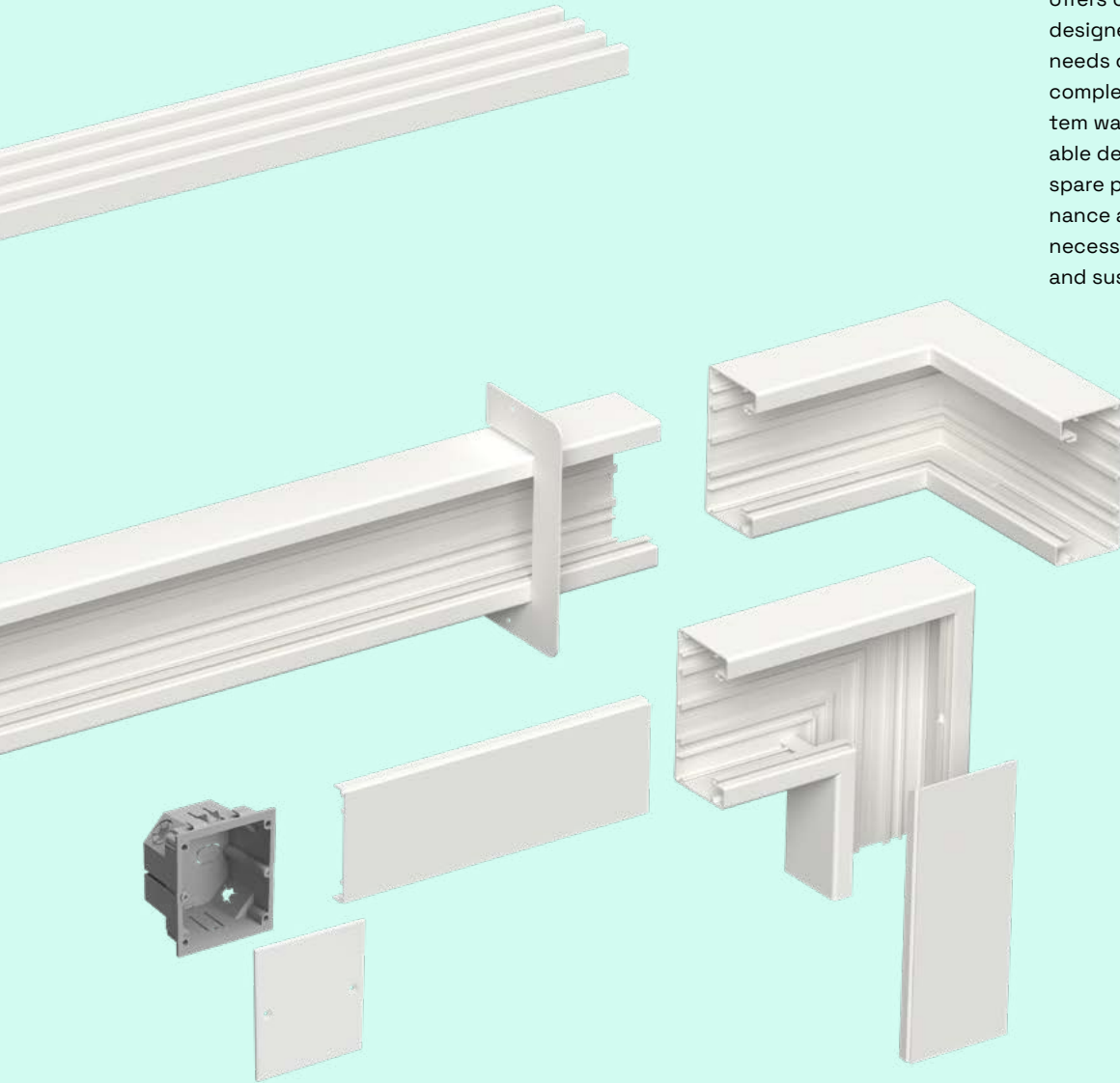

A Sustainable Choice

We believe in designing products that are environmentally friendly and sustainable. With WGX-A, we use recycled aluminium, which reduces the CO₂ footprint by 65% compared to the European average produced.



REDUCES THE
CO₂ FOOTPRINT
BY 65%

Stago WGX-A 110/55

Trunking Base

Low carbon footprint aluminium trunking base with 80 mm front opening. Installs directly onto the wall. Available in powder coated in white or black color. Other optional colors available on request. Use special front opening tool, to prevent damage when removing the 80 mm front cover. Dimension: 110/55/2500 mm. Material: aluminium.





		
Colour	White RAL9003	Black RAL9017
Ref no	STA520005	STA520006
EAN code	7321679003479	7321679003486

Inside corner

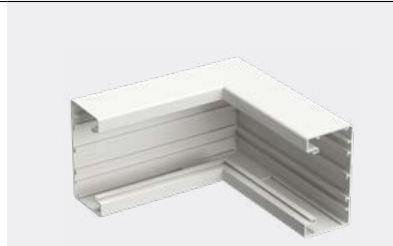
Inside corner with 80 mm front opening. Welded accessorie for perfect fit and ridgid installation. Connect to trunking profile with 4 jointing pieces in aluminium. Available in powder coated in white or black color. Other optional colors available on request. Dimension: 110/55/200 mm. Material: aluminium.





		
Colour	White RAL9003	Black RAL9017
Ref no	STA520051	STA520052
EAN code	7321679003622	7321679003639

Outside corner

Outside corner with 80 mm front opening. 80 mm front cover piece included. Welded accessorie for perfect fit and ridgid installation. Connect to trunking profile with 4 jointing pieces in aluminium. Available in powder coated in white or black color. Other optional colors available on request. Dimension: 110/55/200 mm. Material: aluminium.





		
Colour	White RAL9003	Black RAL9017
Ref no	STA520054	STA520055
EAN code	7321679003356	7321679003349

L-piece

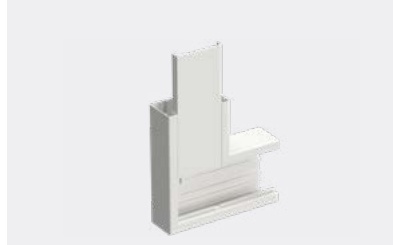
L-piece with 80 mm front opening. 80 mm front cover piece included. Welded accessorie for perfect fit and ridgid installation. Connect to trunking profile with 4 jointing pieces in aluminium. Available in powder coated in white or black color. Other optional colors available on request. Dimension: 110/55/200 mm. Material: aluminium.





		
Colour	White RAL9003	Black RAL9017
Ref no	STA520057	STA520058
EAN code	7321679003660	7321679003677

T-piece

T-piece with 80 mm front opening. 80 mm front cover piece included. Welded accessorie for perfect fit and ridgid installation. Connect to trunking profile with 4 jointing pieces in aluminium. Available in powder coated in white or black color. Other optional colors available on request. Dimension: 110/55/200 mm. Material: aluminium.



		
Colour	White RAL9003	Black RAL9017
Ref no	STA520060	STA520061
EAN code	7321679003684	7321679003691

End piece

End piece to cover the open ends of the trunking base. Installation with screws. Helps protect the installation, and prevents the trunking from being open towards combustible materials if installed on wood or wood fiber walls/ceilings. Dimension: 110/55/34 mm. Material: steel.

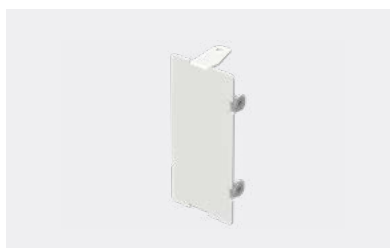

Colour	White RAL9003	Black RAL9017
Ref no	STA520063	STA520064
EAN code	7321679003707	7321679003714

Front Cover

Low carbon footprint aluminium front cover for 80 mm front opening trunking base. Available in powder coated in white or black color. Other optional colors available on request. Use special front opening tool, to prevent damage when removing the 80mm front cover. If functional earth is required, use earth terminal and earth wire. Dimensions: 80/12/2500 mm. Material: aluminium.



Colour	White RAL9003	Black RAL9017
Ref no	STA520011	STA520012
EAN code	7321679003493	7321679003509

Joint cover

Joint cover with self-adhesive tape. Covers the joint between trunking bases if the cut is not perfect, or there is a slight angle difference between the trunking bases. The joint cover piece needs two jointing pieces to be installed to function correct. Sold in pairs. Dimension: 17/55/45 mm. Material: aluminium.

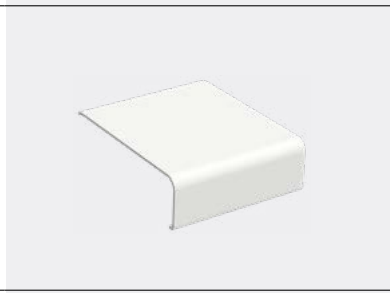

Colour	White RAL9003	Black RAL9017
Ref no	STA500050	STA500051
EAN code	7321679003417	7321679003424

Wall frame

Wall frame with self-adhesive pads. The wall frame covers the hole in the wall. Dimension: 172/86/2 mm. Material: steel.

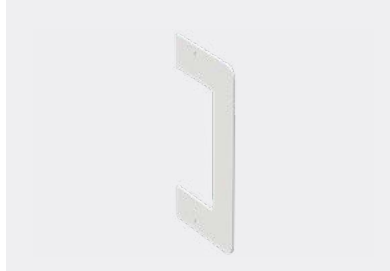

Colour	White RAL9003	Black RAL9017
Ref no	STA500052	STA500053
EAN code	7321679003431	7321679003448

Cable shelf

Divides the trunking into two compartments, separating the power cables from the data cables. Up to 3 cable shelves can be used, to create a maximum of 4 compartments. Dimension: 12/46/500 mm. Material: aluminium.



Ref no	STA520105
EAN code	7321679004926

Jointing and earthing piece

Secures two pieces of trunking. Install by first clicking the Jointing and Earthing Piece into the Trunking (using your fingers or a flat screwdriver). Then fasten the screws using a cross-head screwdriver, to secure equipotential bonding. Sold in pairs. Material: aluminium.



Ref no	STA520085
EAN code	7321679003721

Earthing wire

Secures the functional earth connection between the different components in the trunking installation. 300 mm long, 2.5mm². Equipped with 6.3mm flat tab cable terminals on both sides, green/yellow.



Ref no	STA520086
EAN code	7321679003738

Main earth terminal

Dedicated screw secures tight earth connection. Installs very easy in the trunking base. Fits all Wibe Groups aluminium trunking bases.

Material: electroplated steel.



Ref no STA520097
EAN code 7321679003745

Earth terminal

Earth terminal for earthing of front cover and/or cable shelf. Installation by simply twisting into the 80 mm front cover. Use in combination with earthing wire.

Material: electroplated steel.

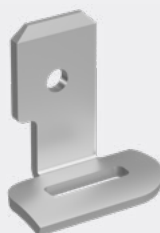



Ref no STA520098
EAN code 7321679003752

Stago WGX-A 120/72

Trunking Base

Low carbon footprint aluminum trunking base with 80 mm front opening. Installs on wall or on fixed or adjustable brackets. Can be divided into compartments by cable shelves. Available in powder coated in white or black color. Other optional colors available on request. Use special front opening tool, to prevent damage when removing the 80 mm front cover. Dimension: 120/72/2500 mm. Material: aluminium.





		
Colour	White RAL9003	Black RAL9017
Ref no	STA520000	STA520001
EAN code	7321679003455	7321679003462

Inside corner

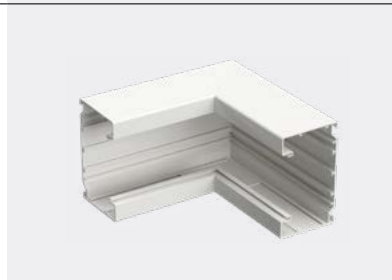
Inside corner with 80 mm front opening. Welded accessorie for perfect fit and ridgid installation. Connect to trunking profile with 4 jointing pieces in aluminium. Available in powder coated in white or black color. Other optional colors available on request. Dimension: 120/72/200 mm. Material: aluminium.





		
Colour	White RAL9003	Black RAL9017
Ref no	STA520019	STA520020
EAN code	7321679003516	7321679003523

Outside corner

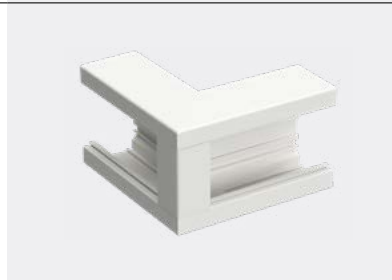
Outside corner with 80 mm front opening. 80 mm front cover piece included. Welded accessorie for perfect fit and ridgid installation. Connect to trunking profile with 4 jointing pieces in aluminium. Available in powder coated in white or black color. Other optional colors available on request. Dimension: 120/72/200 mm. Material: aluminium.





		
Colour	White RAL9003	Black RAL9017
Ref no	STA520022	STA520023
EAN code	7321679003530	7321679003547

L-piece

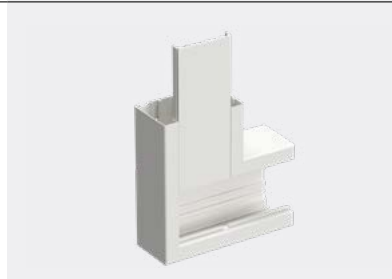
L-piece with 80 mm front opening. 80 mm front cover piece included. Welded accessorie for perfect fit and ridgid installation. Connect to trunking profile with 4 jointing pieces in aluminium. Available in powder coated in white or black color. Other optional colors available on request. Dimension: 120/72/200 mm. Material: aluminium.





		
Colour	White RAL9003	Black RAL9017
Ref no	STA520025	STA520026
EAN code	7321679003554	7321679003561

T-piece

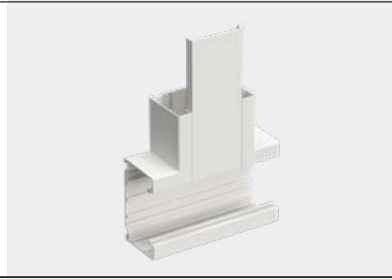
T-piece with 80 mm front opening. 80 mm front cover piece included. Welded accessorie for perfect fit and ridgid installation. Connect to trunking profile with 4 jointing pieces in aluminium. Available in powder coated in white or black color. Other optional colors available on request. Dimension: 120/72/200 mm. Material: aluminium.



		
Colour	White RAL9003	Black RAL9017
Ref no	STA520028	STA520029
EAN code	7321679003578	7321679003585

End piece

End piece to cover the open ends of the trunking base. Installation with screws. Helps protect the installation, and prevents the trunking from being open towards combustible materials if installed on wood or wood fiber walls/ceilings. Dimension: 120/72/34 mm. Material: steel.



Colour	White RAL9003	Black RAL9017
Ref no	STA520031	STA520032
EAN code	7321679003592	7321679003608

End piece

End piece to cover the open ends of the trunking base. Installation without screws. Helps protect the installation, and prevents the trunking from being open towards combustible materials if installed on wood or wood fiber walls/ceilings. Dimension: 120/72/20 mm. Material: PLA plastic, halogen free.



Colour	White RAL9003	Black RAL9017
Ref no	STA500018	STA500019
EAN code	7321679003271	7321679003288

Front Cover

Low carbon footprint aluminium front cover for 80 mm front opening trunking base. Available in powder coated in white or black color. Other optional colors available on request. Use special front opening tool, to prevent damage when removing the 80mm front cover. If functional earth is required, use earth terminal and earth wire. Dimensions: 80/12/2500 mm. Material: aluminium.



Colour	White RAL9003	Black RAL9017
Ref no	STA520011	STA520012
EAN code	7321679003493	7321679003509

Joint cover

Joint cover with self-adhesive tape. Covers the joint between trunking bases if the cut is not perfect, or there is a slight angle difference between the trunking bases. The joint cover piece needs two jointing pieces to be installed to function correct. Sold in pairs. Dimension: 17/72/45 mm. Material: aluminium.



Colour	White RAL9003	Black RAL9017
Ref no	STA500020	STA500021
EAN code	7321679003295	7321679003301

Wall frame

The wall frame has a friction fit to the installation channel. Additional double sided adhesive can be used if needed. The wall frame covers the hole in the wall, but also gives a bit of tolerance to the length of the trunking. If the trunking is cut a bit short, the wall frame will take care of this. Dimension: 190/140/35 mm. Material: PLA plastic, halogen free.



Colour	White RAL9003	Black RAL9017
Ref no	STA500022	STA500023
EAN code	7321679003318	7321679003325

Cable shelf

Divides the trunking into two compartments, separating the power cables from the data cables. Up to 3 cable shelves can be used, to create a maximum of 4 compartments. Dimension: 12/65/500 mm. Material: aluminium.



Ref no	STA520034
EAN code	7321679003615

Fixed wall bracket

Fixed wall bracket in three different depths, from 1 to 4 ventilation ribs. Since the fixed wall bracket is flat on the top surface, it can be used when installing marble, wood or other window seal materials. It can also be used with our ventilation rib holder and ventilation ribs, to allow warm air from the radiator to reach the window. Material: aluminum.



Ref no	STA500059	STA500060
EAN code	7321679003349	7321679003356
Depth	56 mm	79 mm
Vent.ribs	2	3
Ref no	STA500061	
EAN code	7321679003363	
Depth	110 mm	
Vent.ribs	4	

Ventilation rib holder

Ventilation rib holder. The ventilation rib installs securely with the included spring clip. Can be cut to length, and adjusted to the number of ventilation ribs installed. Two clips are included. The clip can be purchased as a spare part if lost. Dimension: 15/34/125 mm. Material: PLA plastic, halogen free.



Ref no	STA500057
EAN code	7321679003660

Ventilation rib

Allows the heat from the radiator to reach the window, and covers the gap between the wall/window and trunking. The trunking should never be installed directly above a radiator, regardless of material. Available in powder coated in white or black color, Other optional colors available on request. Dimensions: 20/10/2500 mm. Material: aluminum.

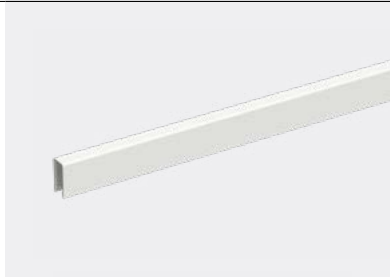

Colour	White RAL9003	Black RAL9017
Ref no	STA500068	STA500069
EAN code	7321679003370	7321679003387

Ventilation rib jointing piece

Jointing piece for ventilation ribs. Grey color. Makes for a nicer installation, when joining two ventilation ribs in mid air. Installs from the bottom of the ventilation rib with a click. Dimension: 19/10/100 mm. Material: PLA plastic, halogen free.



Ref no	STA500070
EAN code	7321679003394

Ventilation rib clip

The clip secures the ventilation rib holder. Material: steel.



Ref no	STA500071
EAN code	7321679003400

Jointing and earthing piece

Secures two pieces of trunking. Install by first clicking the Jointing and Earthing Piece into the Trunking (using your fingers or a flat screwdriver). Then fasten the screws using a cross-head screwdriver, to secure equipotential bonding. Sold in pairs. Material: aluminium.



Ref no	STA520085
EAN code	7321679003721

Earthing wire

Secures the functional earth connection between the different components in the trunking installation. 300 mm long, 2.5mm². Equipped with 6.3mm flat tab cable terminals on both sides, green/yellow.

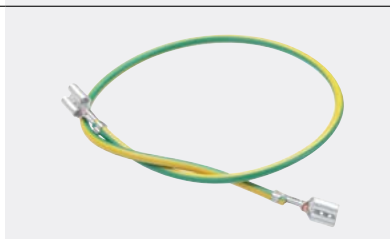

Ref no	STA520086
EAN code	7321679003738

Main earth terminal

Dedicated screw secures tight earth connection. Installs very easy in the trunking base. Fits all Wibe Groups aluminium trunking bases. Material: electroplated steel.



Ref no	STA520097
EAN code	7321679003745

Earth terminal

Earth terminal for earthing of front cover. Installation by simply twisting into the 80 mm front cover. Use in combination with earthing wire. Material: electroplated steel.



Ref no	STA520098
EAN code	7321679003752

Technical data

Standards	The products comply with the standards:
	EN 50085-1 & IEC 61084-1
	EN 50085-2/1 & IEC 61084-2/1
	"The products satisfy the provisions for CE marking according to the Low Voltage Directive 2014/35/EU."
	"The products comply with the RoHS directive 2011/65 EU, REACH Directive 2006/1907 EU (Restriction of Hazardous Substances) "

Material data

Aluminum	
Material	Recycled Aluminum EN AW – 6060 T6, 6061 T6, 6063 T6
Density	2.710 g/cm ³
Surface treatment	Powder Coated
Color Spec	White RAL9003
	Black RAL9017
	Optional Color as per customer requirement
Plastic	
Material	PLA (Polylactic acid)
Density	1.25 g/cm ³
Fire rating	Non-flame propagating ,650 °C, GWT as per IEC 60695-2-11
Color Spec	White RAL9003
	Black RAL9017
Steel	
Material	Pre-galvanized sheet steel in accordance with EN 10346 ,
Density	7.646 g/cm ³
Surface treatment	Zinc coating, Powder coated
Color spec	White RAL9003
	Black RAL9017

Operative data

Temperature range	From -25°C to +60°C
Suitable outdoors	No
Degree of protection	IP20
Suitable for environmental ,Corrosion Class According to ISO 12944-2	C1, C2
Impedance of ducting length or trunking length	0.8 mΩ/m
Trunking access cover retention	Access cover can only be opened with a tool.
Non reusable fasteners	Jointing & earthing piece (STA520085)
	Earth terminal for 80 mm and 40 mm front cover (STA520098)

Cable capacity

110/55

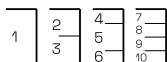

Comp. Diameter No. of wire Cross section area mm² Cable capacity mm² 40% 50% 60%

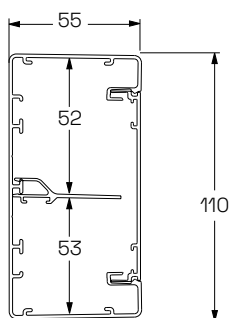

Without mounting boxes					
Comp.	Diameter No.	Cross section area mm ²	Cable capacity mm ² 40%	50%	60%
1	37	4110	1644	2055	2466
2	35	2002	801	1001	1201
3	34	1946	778	973	1168
4	30	1052	421	526	631
5	35	1744	698	872	1047
6	24	1007	403	504	604
7	30	1052	421	526	631
8	23	791	316	395	475
9	23	791	316	395	475
10	24	1007	403	504	604

Compartment 4 and 7 can only be considered for vertical installations.

With 50 mm deep sockets					
Comp.	Diameter No.	Cross section area mm ²	Cable capacity mm ² 40%	50%	60%
1	18	1587	635	793	952
2	18	722	289	361	433
3	18	865	346	433	519
4	18	702	281	351	421
5	0	0	0	0	0
6	18	838	335	419	503
7	18	702	281	351	421
8	0	0	0	0	0
9	0	0	0	0	0
10	18	838	335	419	503

With 45 mm deep sockets					
Comp.	Diameter No.	Cross section area mm ²	Cable capacity mm ² 40%	50%	60%
1	18	1882	753	941	1129
2	18	847	339	423	508
3	18	973	389	487	584
4	18	663	265	331	398
5	8	314	126	157	188
6	18	800	320	400	480
7	18	663	265	331	398
8	8	126	50	63	75
9	8	126	50	63	75
10	18	800	320	400	480

With 23 mm deep sockets					
Comp.	Diameter No.	Cross section area mm ²	Cable capacity mm ² 40%	50%	60%
1	37	3971	1589	1986	2383
2	29	1937	775	968	1162
3	27	1870	748	935	1122
4	25	913	365	456	548
5	37	1729	717	896	1075
6	23	939	376	470	564
7	25	913	365	456	548
8	23	834	333	417	500
9	23	794	317	397	476
10	23	939	376	470	564

120/72

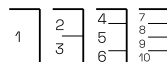

Comp. Diameter No. of wire Cross section area mm² Cable capacity mm² 40% 50% 60%

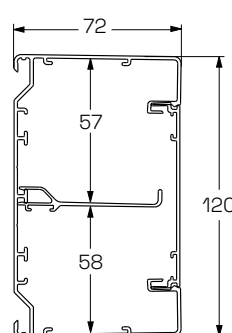

Without mounting boxes					
Comp.	Diameter No.	Cross section area mm ²	Cable capacity mm ² 40%	50%	60%
1	53	6434	2574	3217	3860
2	54	3344	1338	1672	2007
3	51	3084	1234	1542	1850
4	33	1862	745	931	1117
5	48	2792	1117	1396	1675
6	27	1723	689	861	1034
7	33	1862	745	931	1117
8	23	1303	521	651	782
9	23	1303	521	651	782
10	27	1723	689	861	1034

Compartment 4 and 7 can only be considered for vertical installations.

With 50 mm deep sockets					
Comp.	Diameter No.	Cross section area mm ²	Cable capacity mm ² 40%	50%	60%
1	26	4065	1626	2032	2439
2	26	1892	757	946	1135
3	26	2035	814	1017	1221
4	26	1397	559	698	838
5	20	873	349	436	524
6	26	1532	613	766	919
7	26	1397	559	698	838
8	15	362	145	181	217
9	15	373	149	187	224
10	26	1532	613	766	919

With 45 mm deep sockets					
Comp.	Diameter No.	Cross section area mm ²	Cable capacity mm ² 40%	50%	60%
1	25	4212	1685	2106	2527
2	25	1976	790	988	1186
3	25	2092	837	1046	1255
4	25	1368	547	684	821
5	23	1080	432	540	648
6	25	1495	598	747	897
7	25	1368	547	684	821
8	17	468	187	234	281
9	17	468	187	234	281
10	25	1495	598	748	897

With 23 mm deep sockets					
Comp.	Diameter No.	Cross section area mm ²	Cable capacity mm ² 40%	50%	60%
1	53	6301	2520	3151	3781
2	44	3107	1243	1553	1864
3	43	3010	1204	1505	1806
4	36	1674	670	837	1005
5	48	2618	1047	1309	1571
6	30	1656	662	828	994
7	36	1674	670	837	1005
8	23	1238	495	619	743
9	23	1196	478	598	718
10	30	1656	662	828	994

Installation

Aluminium trunking 110, 120

110:	120:
STA520005	STA5520000
STA520006	STA5520001

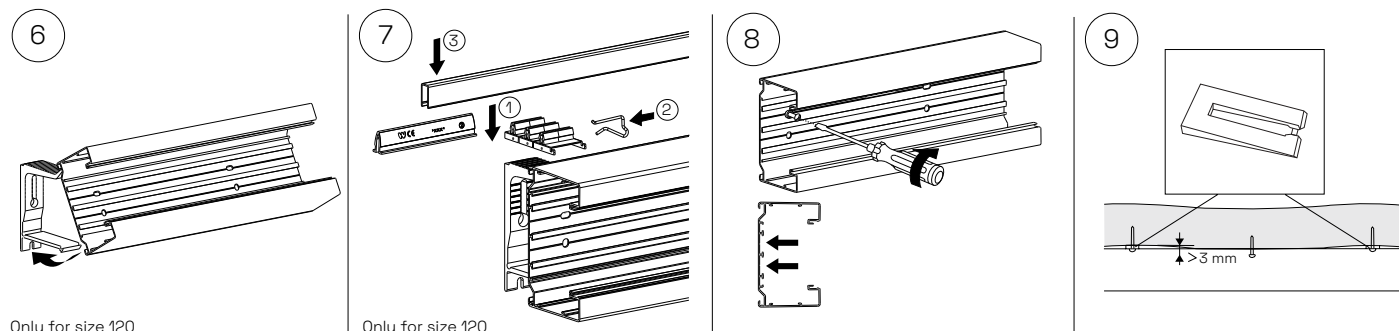
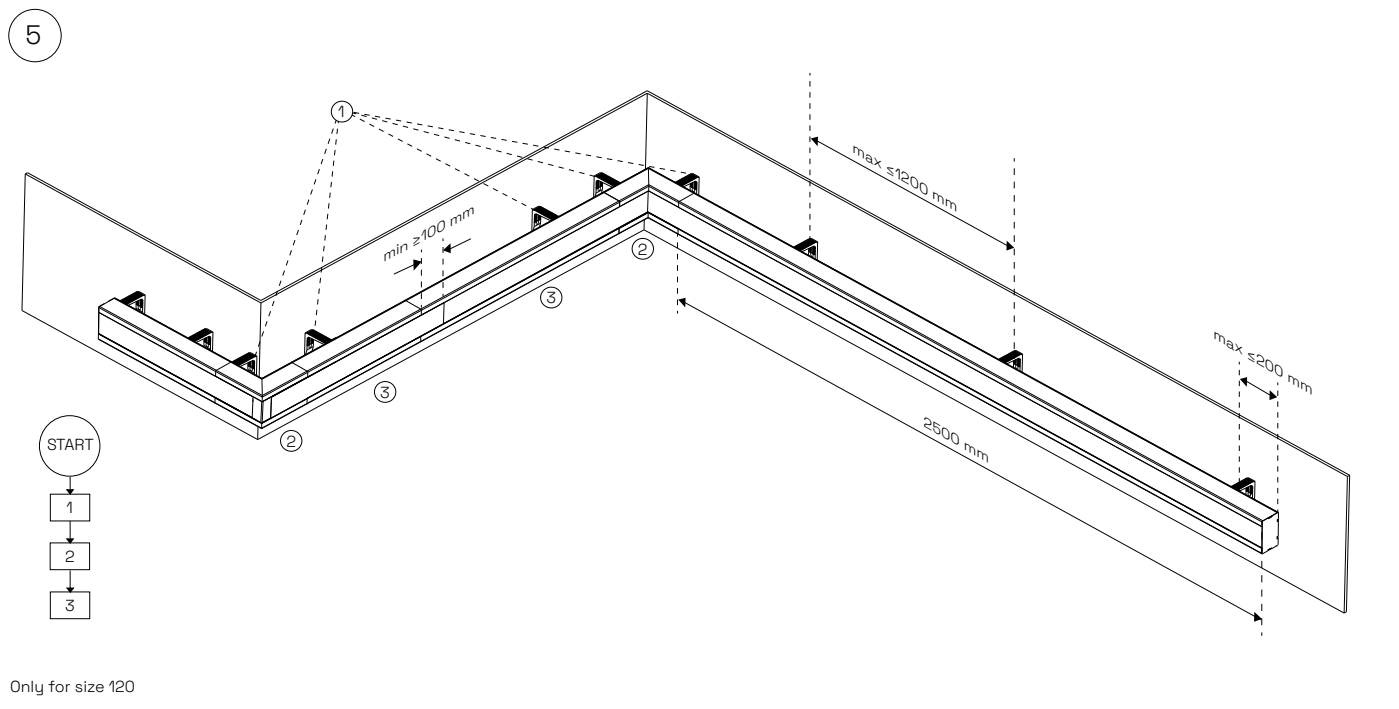
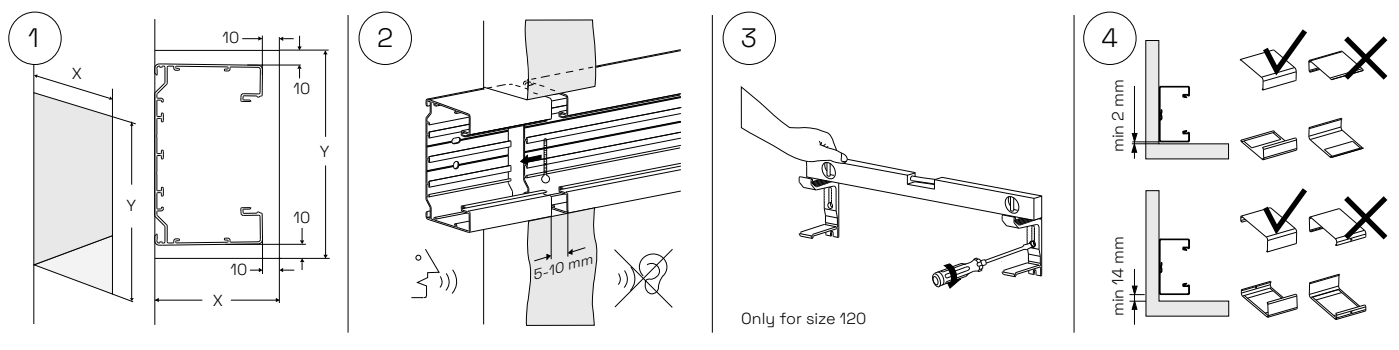
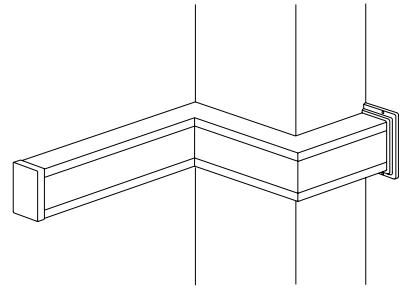

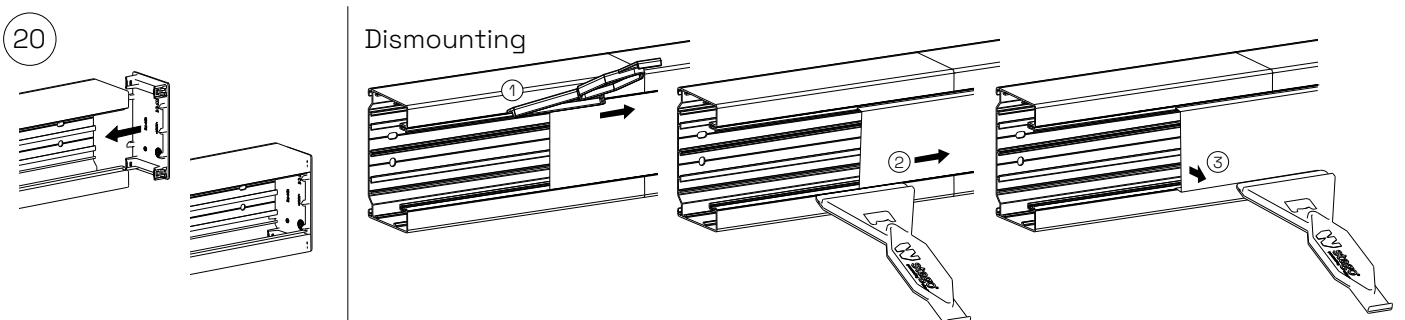
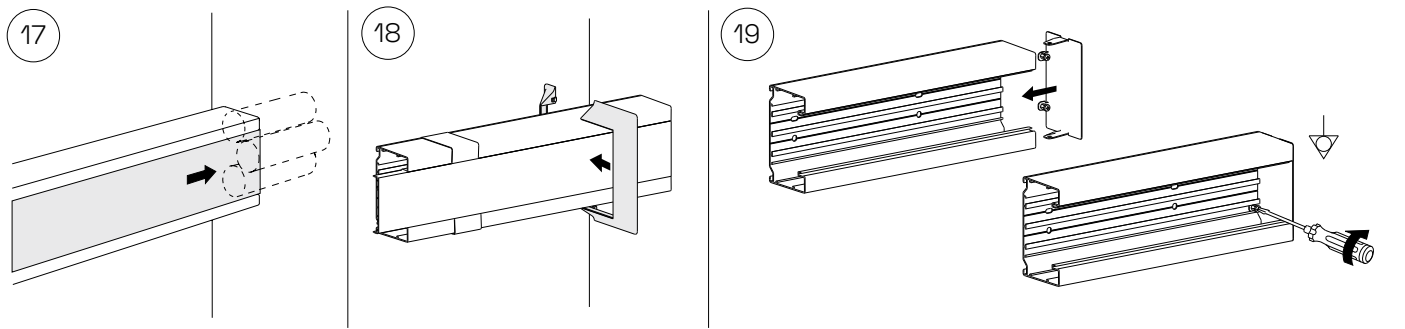
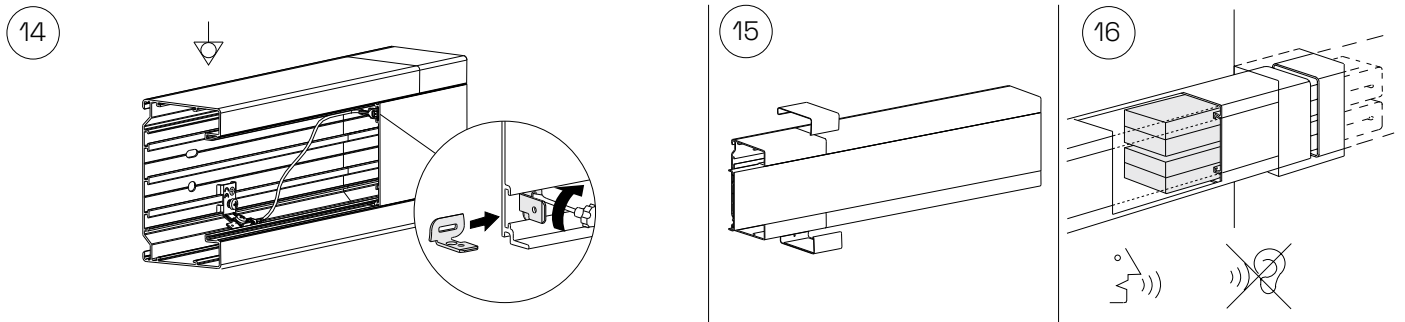
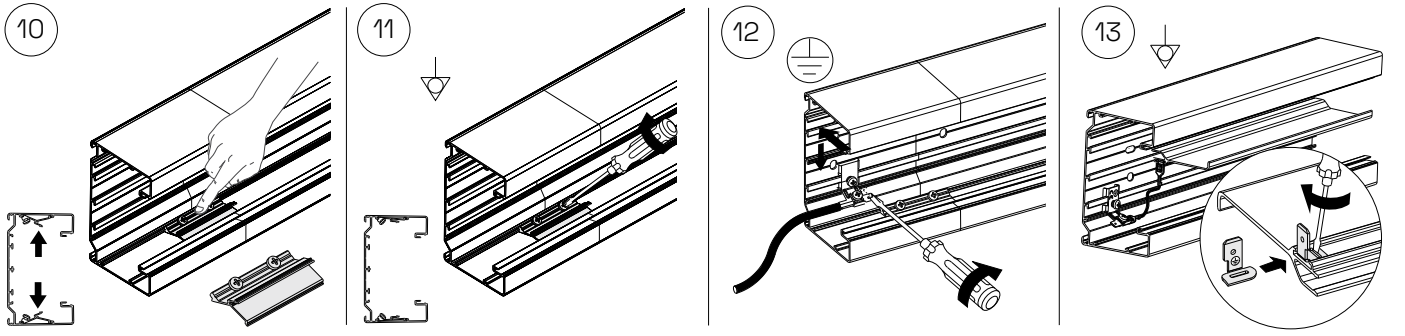

One solution
where all parts
fit together



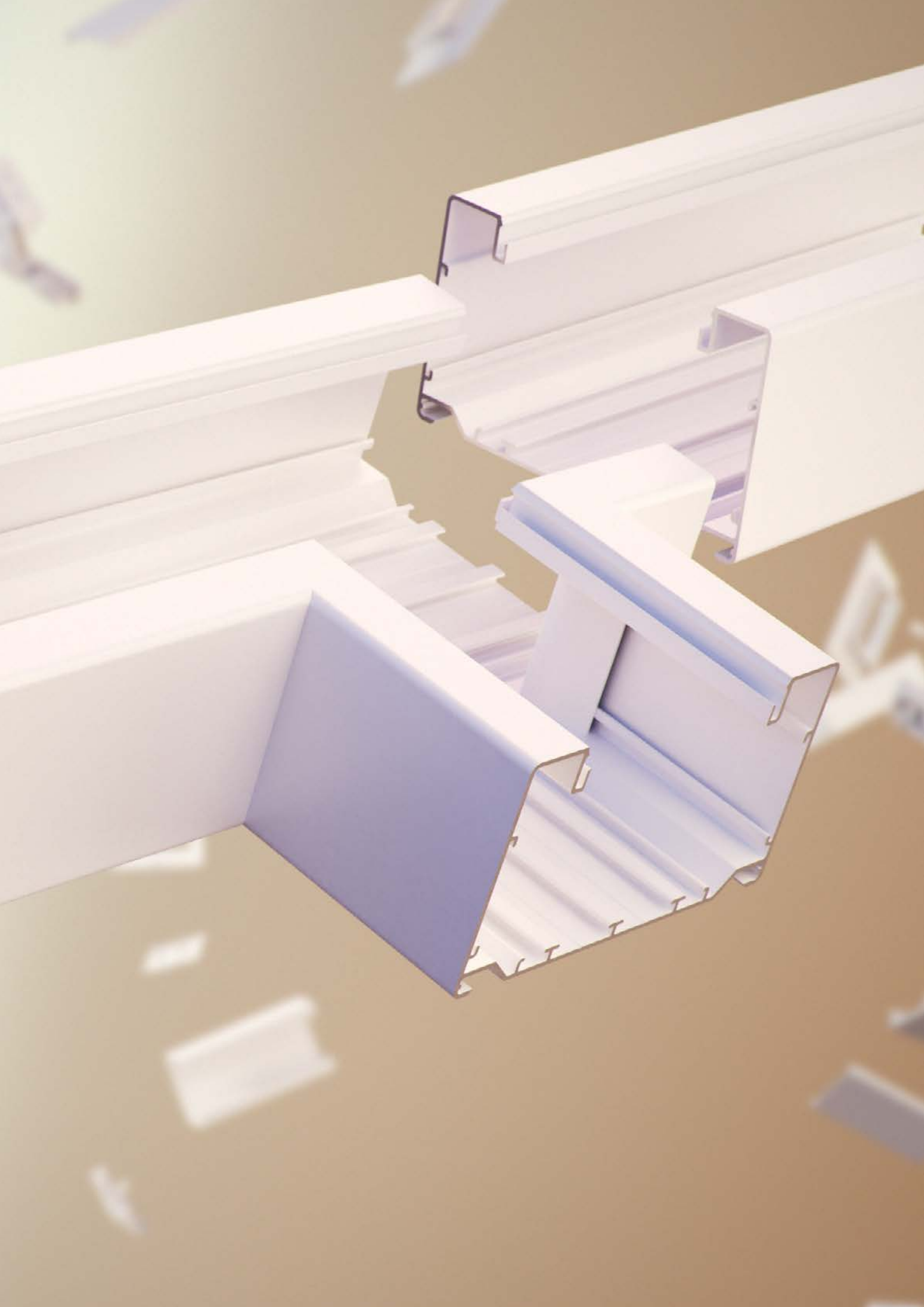

Steel trunking

– strong and versatile,
built to last

Our WGX steel trunking is designed to provide a reliable and long-lasting installation system. Constructed from high-quality steel, this robust trunking offers unparalleled strength and durability, ensuring that your cables are well-protected in even the most demanding environments.

Dependable and resilient

This steel trunking is engineered to be both dependable and resilient. Whether you need to manage power, low voltage, tele, or data cables, our trunking is up to the task, providing the reliability and durability you need to keep your cables organized and secure. Popular in hospital environments due to its excellent shielding properties.

Material: Steel

Available dimensions:

- WGX 110/52
- WGX 110/72
- WGX 120/65
- WGX 130/72
- WGX 165V/52
- WGX 170/65
- WGX 170A/65
- WGX 170(A)/72
- WGX 183/72
- WGX 233/72

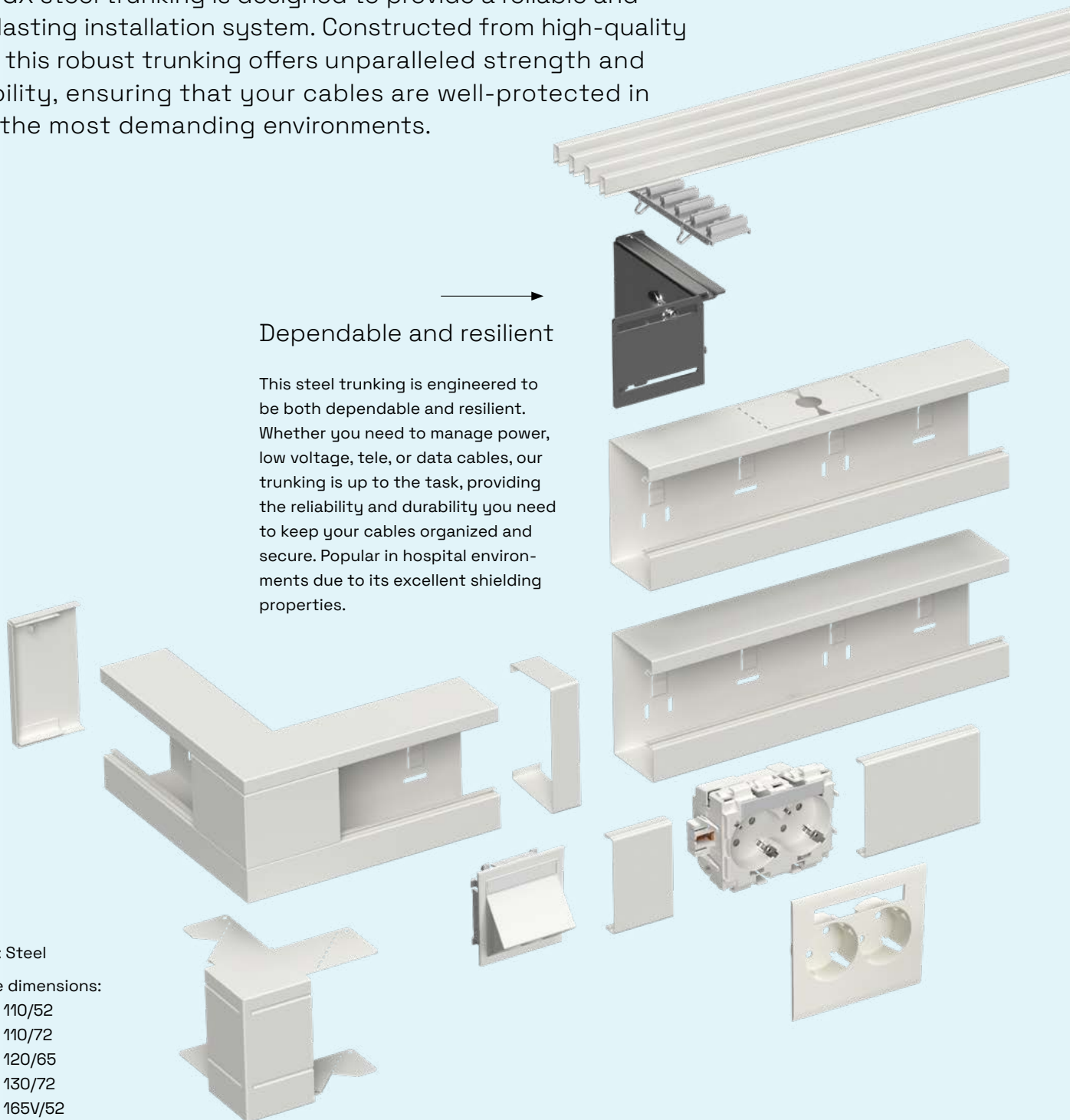

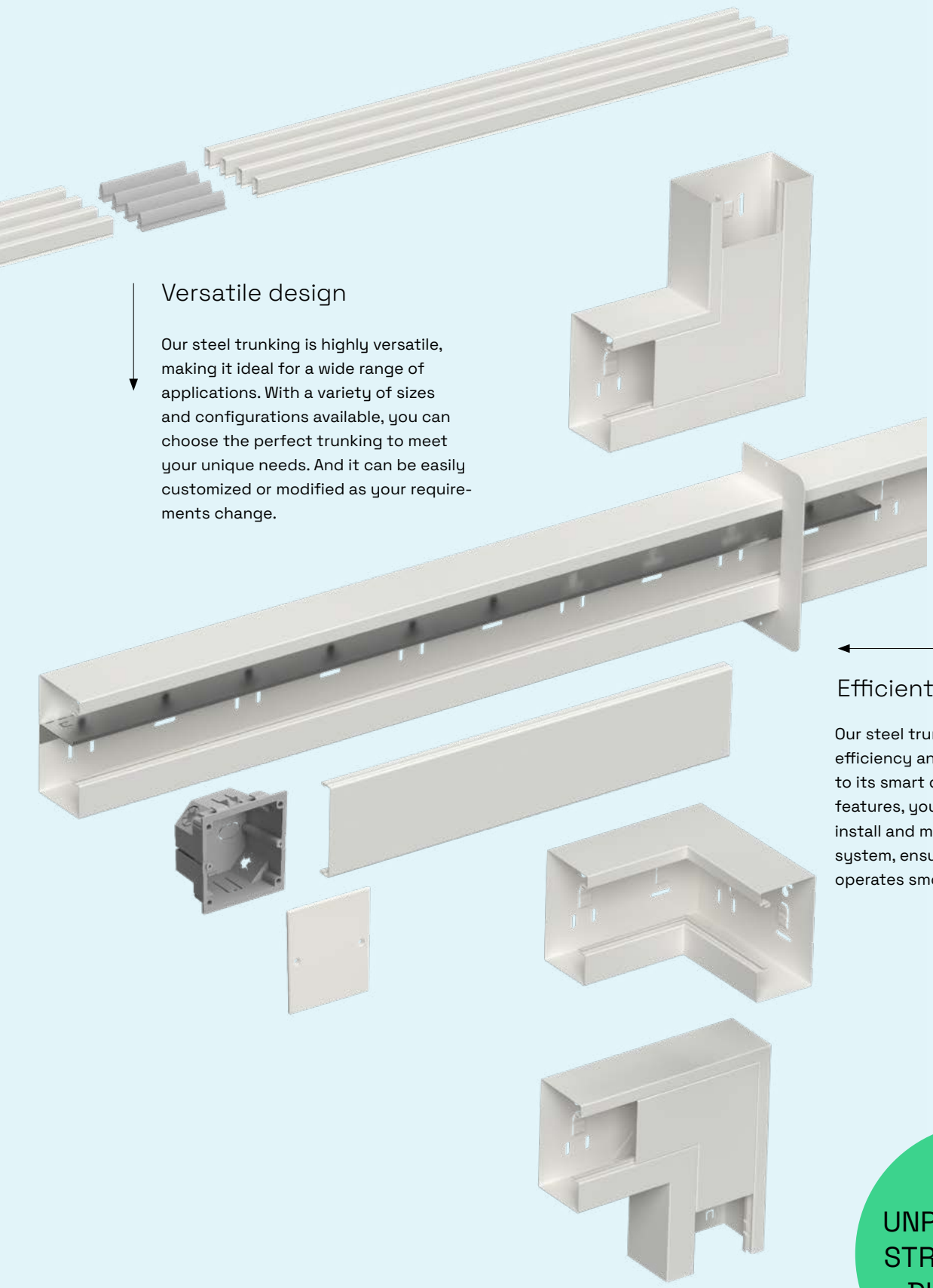

Versatile design

Our steel trunking is highly versatile, making it ideal for a wide range of applications. With a variety of sizes and configurations available, you can choose the perfect trunking to meet your unique needs. And it can be easily customized or modified as your requirements change.

Efficient and effective

Our steel trunking is designed for efficiency and effectiveness. Thanks to its smart design and user-friendly features, you can quickly and easily install and maintain your installation system, ensuring that your business operates smoothly.



**UNPARALLELED
STRENGTH AND
DURABILITY**

Stago WGX 110/52

Trunking Base

Steel trunking base with 80 mm front opening. Installs on wall or on fixed or adjustable brackets. Can be divided into compartments by cable shelves. Powder coated. Dimension: 110/52/2500 mm. Material: steel.





			
Color	White RAL9003	White RAL9010	Black RAL9017
Ref.nr.	STA550004	INS5550003	STA550071
EAN Code	8720871001075	7315880080701	8720871001174

Inside Corner

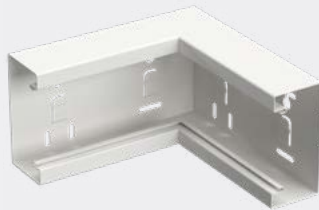
Inside corner with 80 mm front opening. Can be divided into compartments by cable shelves. To be used with sheet steel front cover. Dimension: 110/52/200 mm. Material: steel.





			
Color	White RAL9003	White RAL9010	Black RAL9017
Ref.nr.	STA550005	INS5550203	STA550069
EAN Code	8720871001082	7315880080725	8720871001150

External corner kit

Outside corner with 80 mm front opening, kit including sheet steel front cover. Can be divided into compartments by cable shelves. Dimension: 110/52/200 mm. Material: steel.





			
Color	White RAL9003	White RAL9010	Black RAL9017
Ref.nr.	STA550006	INS5550403	STA550073
EAN Code	8720871001099	7315880080749	8720871001198

Universal corner

Universal corner. Can be used both as internal and external corner. Dimension: 110/52 /130 mm. Material: steel.





			
Color	White RAL9003	White RAL9010	Black RAL9017
Ref.nr.	STA550001	INS5550103	STA550068
EAN Code	8720871001044	7315885550100	8720871001143

L-piece Kit Rise/Drop

90° bend with 80 mm front opening. Kit including sheet steel front cover of 225 mm length. Can be divided into compartments by cable shelves. Dimension: 250/52/250 mm. Material: steel.



			
Color	White RAL9003	White RAL9010	Black RAL9017
Ref.nr.	STA550007	INS5550503	STA550072
EAN Code	8720871001105	7315880080763	8720871001181

T-piece Kit

T-piece kit including sheet steel front cover. With 80 mm front opening and integrated flanges that must be bent up to a 90° angle before assembly. Can be divided into compartments by cable shelves. 110/52/400 mm. Material: steel.

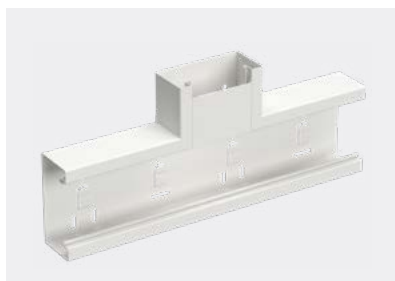

Color	White RAL9003	White RAL9010	Black RAL9017
Ref.nr.	STA550002	INS5550603	STA550070
EAN Code	8720871001051	7315880080787	8720871001167

Stop End

Stop end intended to cover the ends of the trunking base. Dimension: 110/52/11 mm. Material: steel.

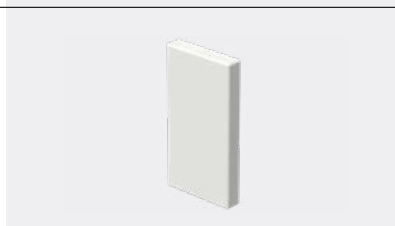

Color	White RAL9003	White RAL9010	Black RAL9017
Ref.nr.	STA550008	INS5550803	STA550075
EAN Code	8720871001112	7315880080824	8720871001211

Cable shelf single 52 mm

Single cable shelf, intended to divide the trunking into compartments. Dimension: 27/40/1000. Material: steel.

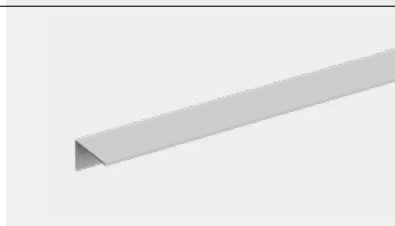

Material	Steel
Ref.nr.	5591730
EAN Code	7315880113355

Cable shelf double 52 mm

Cable shelf, double, intended to divide the trunking into compartments. Dimension: 41/33/1000 mm. Material: steel.



Material	Steel
Ref.nr.	5591733
EAN Code	7315885591738

Front cover 80 mm

Front cover for the 80 mm front opening. The front cover guarantees equipotential bonding when installed in the trunking base. Dimension: 80/12.7/1500 mm. Material: steel.



Color	White RAL9003	White RAL9010	Black RAL9017
Ref.nr.	STA550066	INS5596003	STA550154
EAN Code	8720871002683	7315880097990	8720871002706

Outlet front cover 100 mm

Outlet front cover kit including two front cover pieces, to be fitted on either side of socket outlets. Dimension: 80/12.7/100 mm. Material: steel.

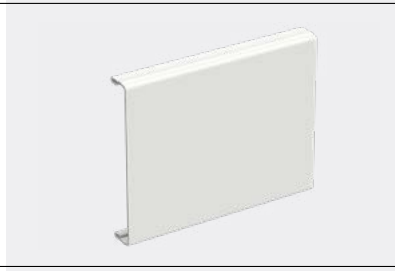

Color	White RAL9003	White RAL9010	Black RAL9017
Ref.nr.	STA550065	INS5596053	STA550155
EAN Code	8720871002676	3606480340789	8720871002713

Outlet front cover 50 mm

Outlet front cover kit including two front cover pieces, to be fitted on either side of socket outlets. Dimension: 80/12.7/50 mm. Material: steel.



Ref.nr.	STA550067	5595107	STA550156
EAN Code	8720871002690	7315880098089	8720871002720

Jointing piece

Joint piece, intended to joint trunking base parts together and connect them to earth between trunking sections. Dimension: 60/51/7 mm. Material: steel.

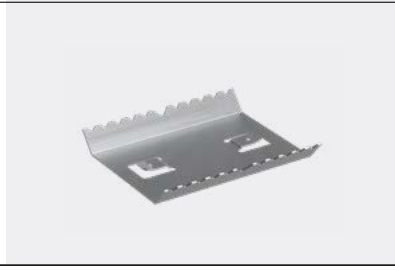

Ref.nr.	5590930
EAN Code	7315885590939

Earth wire 300 mm

Secures the functional earth connection between the different components in the trunking installation. 300 mm long, 2.5mm². Equipped with 6.3mm flat tab cable terminals on both sides, green/yellow.



Ref.nr.  STA520086
 EAN Code 7321679003738

Earthing wire incl. grip-on fixation clips

Secures the electrical bonding connection specifically between cable shelves in the steel trunking installation, Equipped with 6.3mm flat tab cable terminals on both sides and grip-on clips, green/yellow.



Ref.nr.  INS5510953
 EAN Code 7321679004919

Earthing clamp cover

For earthing covers shorter than 100 mm. For 80 mm front cover. Dimensions: 79/5/16 mm. Material: stainless steel.





Ref.nr.  5590509
 EAN Code 7315880098010

Wall bracket fixed Low

Fixed depth wall brackets for mounting at a distance from the wall. Low for up to 130 mm trunking. Two self-drilling screws are included to each product. Material: Steel.







Ref.nr.	 INS55015	 INS55035
EAN Code	3606489420543	3606489420550
Dimension	120/80/15 mm	120/80/35 mm

Wall brackets adjust Low

Adjustable wall bracket for mounting of trunking at a distance from the wall. For 110 and 130 mm high trunking. Material: steel.



Ref.nr.	 5583510	 5583512	 5583514
EAN Code	7315885583511	7315880078647	7315880078654
Dimension	162/126/50	162/126/110	162/126/170
Adjst between	50-70 mm	70-110 mm	110-170 mm

Ref.nr.	 5583516
EAN Code	7315880078661
Dimension	162/126/160
Adjst between	160-260 mm

Ventilation rib holder

Ventilation rib holder. The ventilation rib installs securely with the included spring clip. Can be cut to length, and adjusted to the number of ventilation ribs installed. Two clips are included. The clip can be purchased as a spare part if lost. Dimension: 15/34/125 mm. Material: PLA plastic, halogen free.



Ref no  STA500057
 EAN code 7321679003660



Ventilation rib

Allows the heat from the radiator to reach the window, and covers the gap between the wall/window and trunking. The trunking should never be installed above a radiator, regardless of material. Powder coated or natural anodized versions.

Dimensions: 20/10/2500 mm.

Material: aluminum.



		
Colour	White RAL9003	Black RAL9017
Ref no	STA500068	STA500069
EAN code	7321679003370	7321679003387

Ventilation rib jointing piece

Jointing piece for ventilation ribs. Grey color. Makes for a nicer installation, when joining two ventilation ribs in mid air. Installs from the bottom of the ventilation rib with a click. Dimension: 19/10/100 mm. Material: PLA plastic, halogen free.



	
Ref no	STA500070
EAN code	7321679003608

Ventilation rib clip

The clip secures the ventilation rib holder. Dimension: 38/22 Ø2 mm. Material: steel.



	
Ref no	STA500071
EAN code	7321679003400



Ventilation rib

Ventilation ribs.

Dimension: 20/10/2500 mm.

Material: steel.



			
Color	White RAL9003	White RAL9010	Black RAL9017
Ref.nr.	STA550153	INS5590444	STA550152
EAN Code	8720871004717	8720871002652	8720871002751



Joint Cover piece

Joint cover piece, intended to cover joints between trunking sections.

Dimension: 110/52/30 mm.

Material: steel.





			
Color	White RAL9003	White RAL9010	Black RAL9017
Ref.nr.	STA550009	5595203	STA550074
EAN Code	8720871001129	7315880084976	8720871001204

Wall Frame

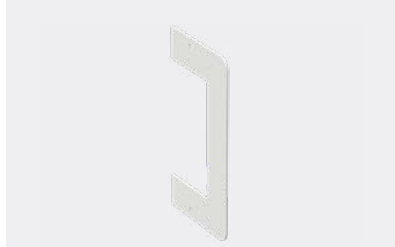
Wall frame to be used to cover a trunking passage through the wall or to make an attractive finish of the trunking against a wall. Dimension: 110/52/11 mm. Material: Steel.





			
Color	White RAL9003	White RAL9010	Black RAL9017
Ref.nr.	STA550003	STA550180	STA550076
EAN Code	8720871001068	8720871001136	8720871001228

Stago WGX 110/72

Trunking Base

Steel trunking base with 80 mm front opening. Installs on wall or on fixed or adjustable brackets. Can be divided into compartments by cable shelves. Powder coated. Dimension: 110/72/2500 mm. Material: steel.





			
Color	White RAL9003	White RAL9010	Black RAL9017
Ref.nr.	STA550013	INS5550013	STA550080
EAN Code	8720871001266	7315880080848	8720871001365

Inside Corner

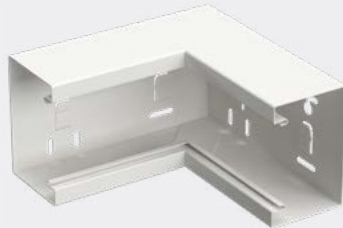
Inside corner with 80 mm front opening. Can be divided into compartments by cable shelves. To be used with sheet steel front cover. Dimension: 110/72/200 mm. Material: steel.





			
Color	White RAL9003	White RAL9010	Black RAL9017
Ref.nr.	STA550014	INS5550213	STA550078
EAN Code	8720871001273	7315880080862	8720871001341

Outside Corner kit

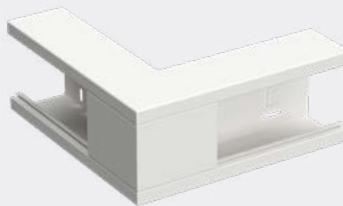
Outside corner with 80 mm front opening, kit including sheet steel front cover. Can be divided into compartments by cable shelves. Dimension: 110/72/200 mm. Material: steel.





			
Color	White RAL9003	White RAL9010	Black RAL9017
Ref.nr.	STA550015	INS5550413	STA550082
EAN Code	8720871001280	7315880080886	8720871001389

Universal Corner

Universal corner. Can be used both as internal and external corner. Dimension: 110/72 /150 mm. Material: steel.





			
Color	White RAL9003	White RAL9010	Black RAL9017
Ref.nr.	STA550010	INS5550123	STA550077
EAN Code	8720871001235	7315885550124	8720871001334

L-piece kit rise/drop

90° bend with 80 mm front opening. Kit including sheet steel front cover of 225 mm length. Can be divided into compartments by cable shelves. Available as riser or dropper. Dimension: 250/72/250 mm. Material: steel.



			
Color	White RAL9003	White RAL9010	Black RAL9017
Ref.nr.	STA550016	INS5550513	STA550081
EAN Code	8720871001297	7315880080909	8720871001372

T-piece kit

T-piece kit including sheet steel front cover. With 80 mm front opening and integrated flanges that must be bent up to a 90° angle before assembly. Can be divided into compartments by cable shelves.
Dimension: 110/72 /400 mm.
Material: steel.

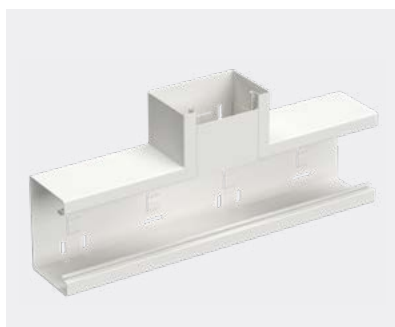

Color	White RAL9003	White RAL9010	Black RAL9017
Ref.nr.	STA550011	INS5550613	STA550079
EAN Code	8720871001242	7315880080923	8720871001358

Stop End

Stop end intended to cover the ends of the trunking base. Available as left-hand and right-hand for some of the trunking sizes.
Dimension: 110/72/11 mm.
Material: steel.



Color	White RAL9003	White RAL9010	Black RAL9017
Ref.nr.	STA550017	INS5550813	STA550084
EAN Code	8720871001303	7315880080961	8720871001402

Cable shelf single 72 mm

Single cable shelf, intended to divide the trunking into compartments.
Dimension: 27/60/1000 mm.
Material: steel.



Material	Steel
Ref.nr.	5591740
EAN Code	7315885591745

Cable shelf double 72 mm

Cable shelf, double, intended to divide the trunking into compartments.
Dimension (steel): 41/52/1000 mm.
Dimension (PVC): 49/61/500 mm.

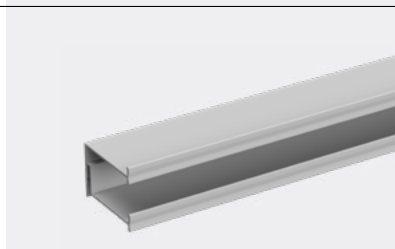

Material	Steel	PVC
Ref.nr.	5591743	5591720
EAN Code	7315880113362	7315885591721

Front cover 80 mm

Front cover for the 80 mm front opening. The front cover guarantees equipotential bonding when installed in the trunking base. Dimension: 80/12.7/1500 mm. Material: steel.



Color	White RAL9003	White RAL9010	Black RAL9017
Ref.nr.	STA550066	INS5596003	STA550154
EAN Code	8720871002683	7315880097990	8720871002706

Outlet front cover 100 mm

Outlet front cover kit including two front cover pieces, to be fitted on either side of socket outlets.
Dimension: 80/12.7/100 mm.
Material: steel.

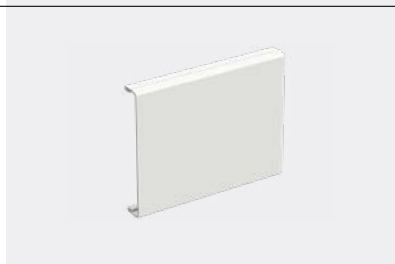

Color	White RAL9003	White RAL9010	Black RAL9017
Ref.nr.	STA550065	INS5596053	STA550155
EAN Code	8720871002676	3606480340789	8720871002713

Outlet front cover 50 mm

Outlet front cover kit including two front cover pieces, to be fitted on either side of socket outlets.
Dimension: 80/12.7/50 mm.
Material: steel.



Color	White RAL9003	White RAL9010	Black RAL9017
Ref.nr.	STA550067	5595107	STA550156
EAN Code	8720871002690	7315880098089	8720871002720

Jointing piece

Joint piece, intended to joint trunking base parts together and connect them to earth between trunking sections. Dimension: 60/71/7 mm.
Material: steel.



Ref.nr.	5590935
EAN Code	7315880066026

Earth wire 300 mm

Secures the functional earth connection between the different components in the trunking installation. 300 mm long, 2.5mm². Equipped with 6.3mm flat tab cable terminals on both sides, green/yellow.



Ref.nr.	STA520086
EAN Code	7321679003738

Earthing wire incl. grip-on fixation clips

Secures the electrical bonding connection specifically between cable shelves in the steel trunking installation, Equipped with 6.3mm flat tab cable terminals on both sides and grip-on clips, green/yellow.



Ref.nr.	INS5510953
EAN Code	7321679004919

Earthing clamp cover

For earthing covers shorter than 100 mm. For 80 mm front cover. Dimensions: 79/5/16 mm. Material: stainless steel.



Ref.nr.	5590509
EAN Code	7315880098010

Wall bracket fixed Low

Fixed depth wall brackets for mounting at a distance from the wall. Low for up to 130 mm trunking. Two self-drilling screws are included to each product. Material: Steel, unpainted.



Ref.nr.	INS55015	INS55035
EAN Code	3606489420543	3606489420550
Dimension	120/80/15 mm	120/80/35 mm

Wall brackets adjust Low

Adjustable wall bracket for mounting of trunking at a distance from the wall. For 110 and 130 mm high trunking. Material: steel.



Ref.nr.	5583510	5583512	5583514
EAN Code	7315885583511	7315880078647	7315880078654
Dimension	162/126/50	162/126/110	162/126/170
Adjust between	50-70 mm	70-110 mm	110-170 mm

Ref.nr.	5583516
EAN Code	7315880078661
Dimension	162/126/160
Adjust between	160-260 mm

Ventilation rib holder

Ventilation rib holder. The ventilation rib installs securely with the included spring clip. Can be cut to length, and adjusted to the number of ventilation ribs installed. Two clips are included. The clip can be purchased as a spare part if lost. Dimension: 15/34/125 mm. Material: PLA plastic, halogen free.

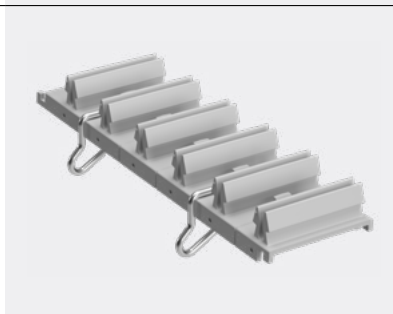

Ref no	STA500057
EAN code	7321679003660



Ventilation rib

Allows the heat from the radiator to reach the window, and covers the gap between the wall/window and trunking. The trunking should never be installed above a radiator, regardless of material. Powder coated or natural anodized versions.

Dimensions: 20/10/2500 mm.

Material: aluminum.



Colour	 White RAL9003	 Black RAL9017
Ref no	STA500068	STA500069
EAN code	7321679003370	7321679003387

Ventilation rib jointing piece

Jointing piece for ventilation ribs. Grey color. Makes for a nicer installation, when joining two ventilation ribs in mid air. Installs from the bottom of the ventilation rib with a click. Dimension: 19/10/100 mm. Material: PLA plastic, halogen free.



Ref no	 STA500070
EAN code	7321679003608

Ventilation rib clip

The clip secures the ventilation rib holder. Dimension: 38/22 Ø2 mm. Material: steel.





Ref no	 STA500071
EAN code	7321679003400

Ventilation rib

Ventilation ribs.
Dimension: 20/10/2500 mm.
Material: steel.





Color	 White RAL9003	 White RAL9010	 Black RAL9017
Ref.nr.	STA550153	INS5590444	STA550152
EAN Code	8720871004717	8720871002652	8720871002751

Joint Cover piece

Joint cover piece, intended to cover joints between trunking sections.
Dimension: 110/72/30 mm.
Material: steel.





Color	 White RAL9003	 White RAL9010	 Black RAL9017
Ref.nr.	STA550018	5595208	STA550083
EAN Code	8720871001310	7315880085010	8720871001396

Wall Frame

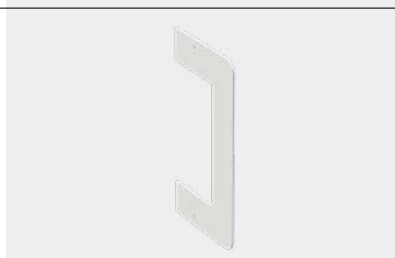
Wall frame to be used to cover a trunking passage through the wall or to make an attractive finish of the trunking against a wall.
Dimension: 110/72/11 mm.
Material: steel.







Color	 White RAL9003	 White RAL9010	 Black RAL9017
Ref.nr.	STA550012	STA550181	STA550085
EAN Code	8720871001259	8720871001327	8720871001419

Stago WGX 120/65

Trunking Base

Steel trunking base with 80 mm front opening. Installs on wall or on fixed or adjustable brackets. Can be divided into compartments by cable shelves. Powder coated. Dimension: 110/65/3000 mm. Material: Steel.







					
Color	White RAL9003	White RAL9010	White RAL1013	Black RAL9017	Unpainted
Ref.nr.	STA550023	INS5551003	INS5551002	STA550090	INS5551000
EAN Code	8720871001471	7315880080046	7315880080053	8720871001600	7315885551008

Inside Corner

Inside corner with 80 mm front opening. Can be divided into compartments by cable shelves. To be used with sheet steel front cover. Dimension: 120/65/200 mm. Material: Steel.





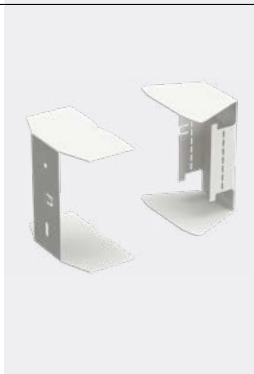

					
Color	White RAL9003	White RAL9010	White RAL1013	Black RAL9017	Unpainted
Ref.nr.	STA550021	INS5551203	INS5551202	STA550088	INS5551200
EAN Code	8720871001457	7315880080220	7315880080237	8720871001587	7315885551206

Inside Corner adjust.

Adjustable internal corner with 80 mm front opening. To be used to fit together two trunking bases that form a certain angle. Dimension: 120/65/115 mm. Material: Steel.







					
Color	White RAL9003	White RAL9010	White RAL1013	Black RAL9017	Unpainted
Ref.nr.	STA550025	INS5551303	INS5551302	STA550092	INS5551300
EAN Code	8720871001495	7315880080282	7315880080299	8720871001624	8720871001686

Outside Corner kit

Outside corner with 80 mm front opening, mm. kit including sheet steel front cover. Can be divided into compartments by cable shelves. Dimension: 120/65/200 mm. Material: Steel.



					
Color	White RAL9003	White RAL9010	White RAL1013	Black RAL9017	Unpainted
Ref.nr.	STA550024	INS5551403	INS5551402	STA550091	INS5551400
EAN Code	8720871001488	7315880080169	7315880080176	8720871001617	7315885551404

Universal Corner

Universal corner.
Can be used both as
internal and external
corner. Dimension:
120/65 /145 mm.
Material: Steel.



Color	White RAL9003	White RAL9010	White RAL1013	Black RAL9017	Unpainted
Ref.nr.	STA550020	INS5551101	INS5551104	STA550087	INS5551105
EAN Code	8720871001440	7315880113607	7315880113614	8720871001570	7315880113621
					STA550174
					8720871001723

L-piece kit rise/ drop

90° bend with 80 mm
front opening. Kit
including sheet steel
front cover of 225 mm
length. Can be divided
into compartments by
cable shelves. Available
as riser or dropper.
Dimension: 250/65/250
mm. Material: Steel.



Color	White RAL9003	White RAL9010	White RAL1013	Black RAL9017	Unpainted
Ref.nr.	STA550026	INS5551503	INS5551502	STA550093	STA550173
EAN Code	8720871001501	7315880080343	7315880080350	8720871001631	8720871001716

T-piece kit

T-piece kit including
sheet steel front cover.
With 80 mm front
opening and integrated
flanges that must be
bent up to a 90° angle
before assembly.
Can be divided into
compartments
by cable shelves.
Dimensions: 120/65/400
mm. Material: Steel.



Color	White RAL9003	White RAL9010	White RAL1013	Black RAL9017	Unpainted
Ref.nr.	STA550022	INS5551603	INS5551602	STA550089	INS5551600
EAN Code	8720871001464	7315880080435	7315880080442	8720871001594	8720871001693

End Piece

Stop end intended
to cover the ends of
the trunking base.
Dimension: 120/65/10
mm. Material: Steel.



Color	White RAL9003	White RAL9010	White RAL1013	Black RAL9017	Unpainted
Ref.nr.	STA550027	INS5551803	INS5551802	STA550094	INS5551800
EAN Code	8720871001518	7315880080558	7315880080565	8720871001648	7315885551800

Branching piece, up, assym

Asymmetrical
branching piece, used
for connection of
feeder trunking 170x40
mm to the trunking
base. Available as
upward. Dimensions:
120/65/400 mm.
Material: Steel.



Color	White RAL9003	White RAL9010	White RAL1013	Black RAL9017	Unpainted
Ref.nr.	STA550028	INS5551703	INS5551702	STA550095	INS5551700
EAN Code	8720871001525	7315880080497	8720871001426	8720871001655	7315885551701

Cable shelf 65 mm single/ double

Cable shelf, single or
double, intended to
divide the trunking
into compartments.
Material: Steel.



Shelf		
Ref.nr.	INS55596100	INS55596110
EAN Code	7315885596108	7315885596115
Dimension	19/55/1500 mm	40/45/1500 mm

Front cover 80 mm

Front cover for the 80 mm front opening. The front cover guarantees equipotential bonding when installed in the trunking base.
Dimension: 80/12.7/1500 mm. Material: steel.



Color	White RAL9003	White RAL9010	White RAL1013	Black RAL9017	Unpainted
Ref.nr.	STA550066	INS5596003	INS5596007	STA550154	INS5596005
EAN Code	8720871002683	7315880097990	7315880098003	8720871002706	7315880097983

Outlet front cover 100 mm

Outlet front cover kit including two front cover pieces, to be fitted on either side of socket outlets.
Dimension: 80/12.7/100 mm. Material: steel.



Color	White RAL9003	White RAL9010	White RAL1013	Black RAL9017	Unpainted
Ref.nr.	STA550065	INS5596053	INS5596052	STA550155	INS5596050
EAN Code	8720871002676	3606480340789	7315880099192	8720871002713	8720871002744

Outlet front cover 50 mm

Outlet front cover kit including two front cover pieces, to be fitted on either side of socket outlets.
Dimension: 80/12.7/50 mm. Material: steel.



Color	White RAL9003	White RAL9010	White RAL1013	Black RAL9017	Unpainted
Ref.nr.	STA550067	5595107	STA550170	STA550156	INS5595115
EAN Code	8720871002690	7315880098089	8720871002669	8720871002720	7315880098034

Jointing piece

Jointing piece intended to joint trunking base parts together and connect them to earth. Provided with punched earthing clips.
Dimension: 8/65/60 mm. Material: Stainless steel.



Ref.nr.	INS5596240
EAN Code	7315880080640

Earth wire 300 mm

Secures the functional earth connection between the different components in the trunking installation. 300 mm long, 2.5mm². Equipped with 6.3mm flat tab cable terminals on both sides, green/yellow.



Ref.nr.	STA520086
EAN Code	7321679003738

Earthing wire incl. grip-on fixation clips

Secures the electrical bonding connection specifically between cable shelves in the steel trunking installation, Equipped with 6.3mm flat tab cable terminals on both sides and grip-on clips, green/yellow.



Ref.nr.	INS5510953
EAN Code	7321679004919

Earthing clamp cover

For earthing covers shorter than 100 mm. For 80 mm front cover. Dimensions: 79/5/16. Material: stainless steel.



Ref.nr.	5590509
EAN Code	7315880098010

Wall brackets adjust

Adjustable wall bracket for mounting of trunking at a distance from the wall. Suitable for steel trunking 120/65, 170/65, 170A/65.



Ref.nr.	5583550	5583552	5583554	5583556	5583558
EAN Code	7315885583559	7315880083931	7315880083948	7315880083955	7315880083962
Dimension	162/126/50	162/126/70	162/126/110	162/126/160	162/126/250
Adjst between	50-70 mm	70-110 mm	110-170 mm	160-260 mm	250-400 mm

Ventilation rib holder

Ventilation rib holder. The ventilation rib installs securely with the included spring clip. Can be cut to length, and adjusted to the number of ventilation ribs installed. Two clips are included. The clip can be purchased as a spare part if lost. Dimension: 15/34/125 mm. Material: PLA plastic, halogen free.



Ref no	STA500057
EAN code	7321679003660

Ventilation rib

Allows the heat from the radiator to reach the window, and covers the gap between the wall/window and trunking. The trunking should never be installed above a radiator, regardless of material. Powder coated or natural anodized versions. Dimensions: 20/10/2500 mm. Material: aluminum.



Colour	White RAL9003	Black RAL9017
Ref no	STA500068	STA500069
EAN code	7321679003370	7321679003387

Ventilation rib jointing piece

Jointing piece for ventilation ribs. Grey color. Makes for a nicer installation, when joining two ventilation ribs in mid air. Installs from the bottom of the ventilation rib with a click. Dimension: 19/10/100 mm. Material: PLA plastic, halogen free.



Ref no	STA500070
EAN code	7321679003608

Ventilation rib clip

The clip secures the ventilation rib holder. Dimension: 38/22 Ø2 mm. Material: steel.



Ref no	STA500071
EAN code	7321679003400

Ventilation rib

Ventilation ribs. Dimension: 20/10/2500 mm. Material: steel.



Color	White RAL9003	White RAL9010	Black RAL9017
Ref.nr.	STA550153	INS5590444	STA550152
EAN Code	8720871004717	8720871002652	8720871002751

Joint Cover piece

Joint cover piece, intended to cover joints between trunking sections. Dimension: 120/65/30 mm. Material: steel.



Color	White RAL9003	White RAL9010	White RAL1013	Black RAL9017	Unpainted
Ref.nr.	STA550029	5595223	5595222	STA550096	STA550175
EAN Code	8720871001532	7315880085072	7315880085065	8720871001662	8720871001730

Wall Frame

Wall frame to be used to cover a trunking passage through the wall or to make an attractive finish of the trunking against a wall. Dimension: 182/96/1.5 mm. Material: steel.



Color	White RAL9003	White RAL9010	Black RAL9017	Unpainted
Ref.nr.	STA550030	STA550182	STA550097	STA550183
EAN Code	8720871001549	8720871001556	8720871001679	8720871001747

Wall frame

Wall frame to be used to cover a trunking passage through the wall or to make an attractive finish of the trunking against a wall. Dimension: 170/90/10 mm. Material: PVC.



Color	White RAL9010	White RAL1013
Ref.nr.	INS19161270	INS19161200
EAN Code	8712186019203	8712186019197

Saw support

Saw support/cutting jig for easy cutting of the trunking length. Dimension: 120/65/- Material: Wood.





Ref.nr.	INS5596230
EAN Code	7315885596238

Stago WGX 130/72

Trunking Base

Steel trunking base with 80 mm front opening. Installs on wall or on fixed or adjustable brackets. Can be divided into compartments by cable shelves. Powder coated. Dimension: 130/72/2500 mm. Material: Steel.





			
Color	White RAL9003	White RAL9010	Black RAL9017
Ref.nr.	STA550036	INS5552003	STA550103
EAN Code	8720871001792	7315880081128	8720871001921

Inside Corner

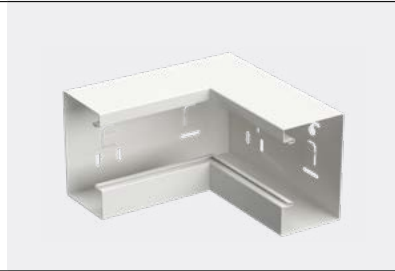
Inside corner with 80 mm front opening. Can be divided into compartments by cable shelves. To be used with sheet steel front cover. Dimension: 130/72/200 mm. Material: Steel.





			
Color	White RAL9003	White RAL9010	Black RAL9017
Ref.nr.	STA550037	INS5552203	STA550100
EAN Code	8720871001808	7315880081142	8720871001891

Outside Corner

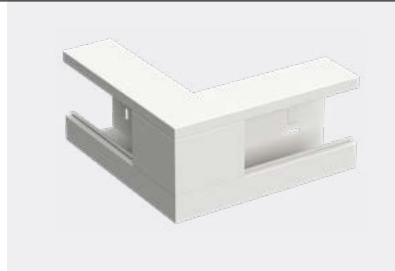
Outside corner with 80 mm front opening, kit including sheet steel front cover. Can be divided into compartments by cable shelves. Dimension: 130/72/200 mm. Material: Steel.





			
Color	White RAL9003	White RAL9010	Black RAL9017
Ref.nr.	STA550038	INS5552403	STA550106
EAN Code	8720871001815	7315880081166	8720871001952

Universal Corner

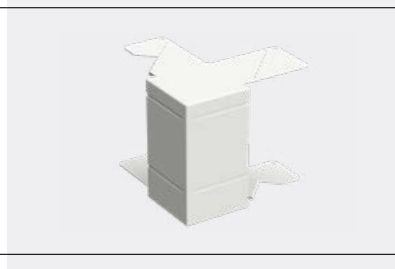
Universal corner. Can be used both as internal and external corner. Dimension: 130/72 /150 mm. Material: Steel.





			
Color	White RAL9003	White RAL9010	Black RAL9017
Ref.nr.	STA550031	INS5552123	STA550098
EAN Code	8720871001754	7315885552128	8720871001884

L-piece kit dropper

90° bend with 80 mm front opening. Dropper. Kit including sheet steel front cover of 225 mm length. Can be divided into compartments by cable shelves. Dimension: 250/72/250 mm. Material: Steel.



			
Color	White RAL9003	White RAL9010	Black RAL9017
Ref.nr.	STA550040	INS5552509	STA550105
EAN Code	8720871001839	7315880081210	8720871001945

L-piece kit riser

90° bend with 80 mm front opening. Riser. Kit including sheet steel front cover of 225 mm length. Can be divided into compartments by cable shelves. Dimension: 250/72/250 mm. Material: Steel.



Color	White RAL9003	White RAL9010	Black RAL9017
Ref.nr.	STA550039	INS5552503	STA550104
EAN Code	8720871001822	7315880081180	8720871001938

T-piece dropper

T-piece with 80 mm front opening and integrated flanges that must be bent up to a 90° angle before assembly. Dropper. Can be divided into compartments by cable shelves. To be used with sheet steel front cover. Dimensions: 130/72/400 mm. Material: Steel.



Color	White RAL9003	White RAL9010	Black RAL9017
Ref.nr.	STA550034	STA550171	STA550102
EAN Code	8720871001778	8720871001860	8720871001914

T-piece riser

T-piece with 80 mm front opening and integrated flanges that must be bent up to a 90° angle before assembly. Riser. Can be divided into compartments by cable shelves. To be used with sheet steel front cover. Dimensions: 130/72/400 mm. Material: Steel.

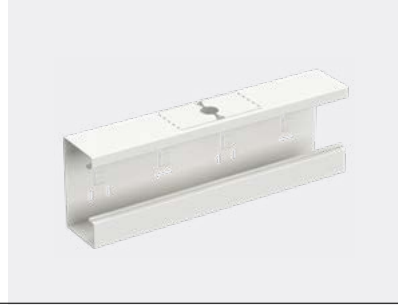

Color	White RAL9003	White RAL9010	Black RAL9017
Ref.nr.	STA550033	INS5552603	STA550101
EAN Code	8720871001761	7315880081234	8720871001907

End Piece

Stop end intended to cover the ends of the trunking base. Dimension: 130/72/11 mm. Material: Steel.



Color	White RAL9003	White RAL9010	Black RAL9017
Ref.nr.	STA550041	INS5552803	STA550108
EAN Code	8720871001846	7315880081302	8720871001976

Cable shelf single 72 mm

Single cable shelf, intended to divide the trunking into compartments. Dimension: 27/60/1000 mm. Material: steel.

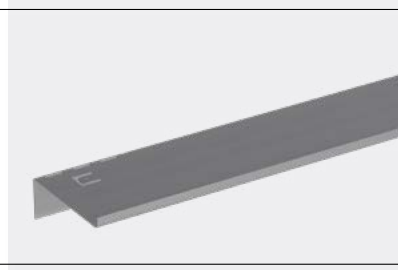

Material	Steel
Ref.nr.	5591740
EAN Code	7315885591745

Cable shelf double 72 mm

Cable shelf, double, intended to divide the trunking into compartments. Dimension (steel): 41/52/1000 mm. Dimension (PVC): 49/61/500 mm.

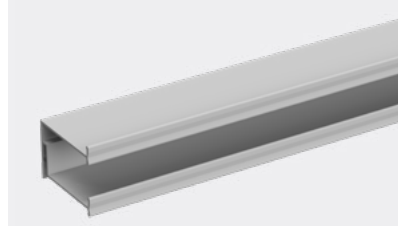

Material	Steel	PVC
Ref.nr.	5591743	5591720
EAN Code	7315880113362	7315885591721

Front cover 80 mm

Front cover for the 80 mm front opening. The front cover guarantees equipotential bonding when installed in the trunking base. Dimension: 80/12.7/1500 mm. Material: steel.



Color	White RAL9003	White RAL9010	Black RAL9017
Ref.nr.	STA550066	INS5596003	STA550154
EAN Code	8720871002683	7315880097990	8720871002706

Outlet front cover 100 mm

Outlet front cover kit including two front cover pieces, to be fitted on either side of socket outlets. Dimension: 80/12.7/100 mm. Material: steel.



Color	White RAL9003	White RAL9010	Black RAL9017
Ref.nr.	STA550065	INS5596053	STA550155
EAN Code	8720871002676	3806480340789	8720871002713

Outlet front cover 50 mm

Outlet front cover kit including two front cover pieces, to be fitted on either side of socket outlets. Dimension: 80/12.7/50 mm. Material: steel.



Color	White RAL9003	White RAL9010	Black RAL9017
Ref.nr.	STA550067	5595107	STA550156
EAN Code	8720871002690	7315880098089	8720871002720

Jointing piece

Joint piece, intended to joint trunking base parts together and connect them to earth between trunking sections. Dimension: 60/71/7 mm. Material: steel.



Ref.nr.	5590935
EAN Code	7315880066026

Earth wire 300 mm

Secures the functional earth connection between the different components in the trunking installation. 300 mm long, 2.5mm². Equipped with 6.3mm flat tab cable terminals on both sides, green/yellow.



Ref.nr.	STA520086
EAN Code	7321679003738

Earthing wire incl. grip-on fixation clips

Secures the electrical bonding connection specifically between cable shelves in the steel trunking installation, Equipped with 6.3mm flat tab cable terminals on both sides and grip-on clips, green/yellow.



Ref.nr.	INS5510953
EAN Code	7321679004919

Earthing clamp cover

For earthing covers shorter than 100 mm. For 80 mm front cover. Dimensions: 79/5/16. Material: stainless steel.



Ref.nr.	5590509
EAN Code	7315880098010

Wall bracket fixed Low

Fixed depth wall brackets for mounting at a distance from the wall. Low for up to 130 mm trunking. Two self-drilling screws are included to each product. Material: Steel, unpainted.



Ref.nr.	INS55015	INS55035
EAN Code	3606489420543	3606489420550
Dimension	120/80/15 mm	120/80/35 mm

Wall brackets adjust Low

Adjustable wall bracket for mounting of trunking at a distance from the wall. For 110 and 130 mm high trunking. Material: steel.



Ref.nr.	5583510	5583512	5583514
EAN Code	7315885583511	7315880078647	7315880078654
Dimension	162/126/50	162/126/110	162/126/170
Adjst between	50-70 mm	70-110 mm	110-170 mm
Ref.nr.	5583516		
EAN Code	7315880078661		
Dimension	162/126/160		
Adjst between	160-260 mm		

Ventilation rib holder

Ventilation rib holder. The ventilation rib installs securely with the included spring clip. Can be cut to length, and adjusted to the number of ventilation ribs installed. Two clips are included. The clip can be purchased as a spare part if lost. Dimension: 15/34/125 mm. Material: PLA plastic, halogen free.



Ref no	STA500057
EAN code	7321679003660

Ventilation rib

Allows the heat from the radiator to reach the window, and covers the gap between the wall/window and trunking. The trunking should never be installed above a radiator, regardless of material. Powder coated or natural anodized versions. Dimensions: 20/10/2500 mm. Material: aluminum.



Colour	White RAL9003	Black RAL9017
Ref no	STA500068	STA500069
EAN code	7321679003370	7321679003387

Ventilation rib jointing piece

Jointing piece for ventilation ribs. Grey color. Makes for a nicer installation, when joining two ventilation ribs in mid air. Installs from the bottom of the ventilation rib with a click. Dimension: 19/10/100 mm. Material: PLA plastic, halogen free.



Ref no	STA500070
EAN code	7321679003608

Ventilation rib clip

The clip secures the ventilation rib holder. Dimension: 38/22 Ø2 mm. Material: steel.



Ref no	STA500071
EAN code	7321679003400

Ventilation rib

Ventilation ribs. Dimension: 20/10/2500 mm. Material: steel.



Color	White RAL9003	White RAL9010	Black RAL9017
Ref.nr.	STA550153	INS5590444	STA550152
EAN Code	8720871004717	8720871002652	8720871002751

Joint Cover piece

Joint cover piece, intended to cover joints between trunking sections. Dimension: 130/72/30 mm. Material: Steel.



Color	White RAL9003	White RAL9010	Black RAL9017
Ref.nr.	STA550042	5595243	STA550109
EAN Code	8720871001853	7315880085102	8720871001983

Wall Frame

Wall frame to be used to cover a trunking passage through the wall or to make an attractive finish of the trunking against a wall. Dimension: 192/103/1.5 mm. Material: Steel.

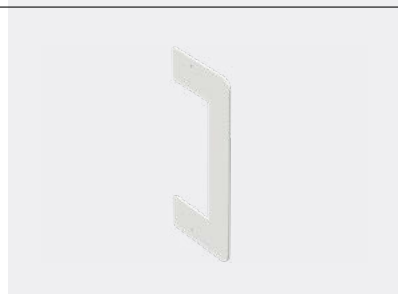



Color	White RAL9003	White RAL9010	Black RAL9017
Ref.nr.	STA550035	STA550184	STA550109
EAN Code	8720871001785	8720871001877	8720871001983

Stago WGX 165V/52

Trunking Base

Steel trunking base with 80 mm front opening. Installs on wall or on fixed or adjustable brackets. Can be divided into compartments by cable shelves. Powder coated. Dimension: 165/52/2500 mm. Material: Steel.





			
Color	White RAL9003	White RAL9010	Black RAL9017
Ref.nr.	STA550045	INS5554003	STA550112
EAN Code	8720871002010	7315880081524	8720871002096

Inside Corner

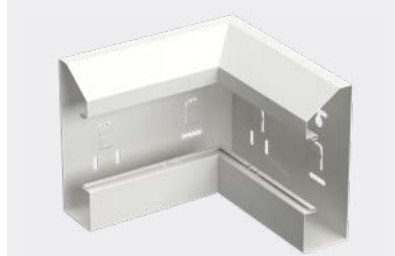
Inside corner with 80 mm front opening. Can be divided into compartments by cable shelves. To be used with sheet steel front cover. Dimension: 165/52/200 mm. Material: Steel.





			
Color	White RAL9003	White RAL9010	Black RAL9017
Ref.nr.	STA550043	INS5554203	STA550110
EAN Code	8720871001990		8720871002072

Outside Corner

Outside corner with 80 mm front opening, kit including sheet steel front cover. Can be divided into compartments by cable shelves. Dimension: 165/52/200 mm. Material: Steel.





			
Color	White RAL9003	White RAL9010	Black RAL9017
Ref.nr.	STA550047	INS5554403	STA550114
EAN Code	8720871002034	7315880081562	8720871002119

L-piece kit riser

90° bend with 80 mm front opening. Riser. Kit including sheet steel front cover of 225 mm length. Can be divided into compartments by cable shelves. Dimension: 250/52/250 mm. Material: Steel.





			
Color	White RAL9003	White RAL9010	Black RAL9017
Ref.nr.	STA550046	INS5554503	STA550113
EAN Code	8720871002027	3606480340611	8720871002102

T-piece kit

T-piece kit including sheet steel front cover. With 80 mm front opening and integrated flanges that must be bent up to a 90° angle before assembly. Can be divided into compartments by cable shelves. 165/52/400 mm. Material: Steel.



			
Color	White RAL9003	White RAL9010	Black RAL9017
Ref.nr.	STA550044	INS5554603	STA550111
EAN Code	8720871002003	3606480340635	8720871002099

End piece left

Stop end intended to cover the ends of the trunking base. Left.
Dimension: 165/52/11 mm.
Material: Steel.



Color	White RAL9003	White RAL9010	Black RAL9017
Ref.nr.	STA550049	INS5554803	STA550116
EAN Code	8720871002058	3606480340659	8720871002133

End piece right

Stop end intended to cover the ends of the trunking base. Right.
Dimension: 165/52/11 mm.
Material: Steel.



Color	White RAL9003	White RAL9010	Black RAL9017
Ref.nr.	STA550050	INS5554808	STA550117
EAN Code	8720871002065	3606480340666	8720871002140

Cable shelf single 52 mm

Single cable shelf, intended to divide the trunking into compartments.
Dimension: 27/40/1000.
Material: steel.

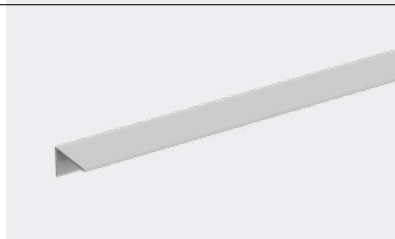

Material	Steel
Ref.nr.	5591730
EAN Code	7315880113355

Cable shelf double 52 mm

Cable shelf, double, intended to divide the trunking into compartments.
Dimension: 41/33/1000 mm.
Material: steel.



Material	Steel
Ref.nr.	5591733
EAN Code	7315885591738

Front cover 80 mm

Front cover for the 80 mm front opening. The front cover guarantees equipotential bonding when installed in the trunking base.
Dimension: 80/12.7/1500 mm.
Material: steel.

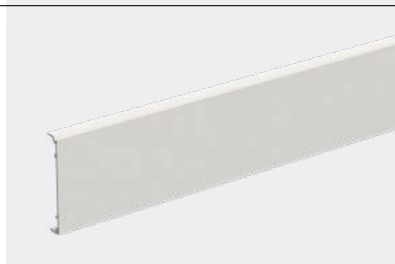

Color	White RAL9003	White RAL9010	Black RAL9017
Ref.nr.	STA550066	INS5596003	STA550154
EAN Code	8720871002683	7315880097990	8720871002706

Outlet front cover 100 mm

Outlet front cover kit including two front cover pieces, to be fitted on either side of socket outlets.
Dimension: 80/12.7/100 mm.
Material: steel.



Color	White RAL9003	White RAL9010	Black RAL9017
Ref.nr.	STA550065	INS5596053	STA550155
EAN Code	8720871002676	3606480340789	8720871002713

Outlet front cover 50 mm

Outlet front cover kit including two front cover pieces, to be fitted on either side of socket outlets.
Dimension: 80/12.7/50 mm.
Material: steel.



Color	White RAL9003	White RAL9010	Black RAL9017
Ref.nr.	STA550067	5595107	STA550156
EAN Code	8720871002690	7315880098089	8720871002720

Joining piece

Joint piece, intended to joint trunking base parts together and connect them to earth between trunking sections. Dimension: 60/51/7 mm.
Material: steel.



Ref.nr.	5590930	5590950
EAN Code	7315885590939	7315885590953

Joint Cover piece

Joint cover piece, intended to cover joints between trunking sections.
Dimension: 165/52/30 mm.
Material: steel.



Color	White RAL9003	White RAL9010	Black RAL9017
Ref.nr.	STA550048	5595263	STA550115
EAN Code	8720871002041	7315880085171	8720871002126

Earth wire 300 mm

Secures the functional earth connection between the different components in the trunking installation. 300 mm long, 2.5mm². Equipped with 6.3mm flat tab cable terminals on both sides, green/yellow.



Ref.nr.	STA520086
EAN Code	7321679003738

Earthing wire incl. grip-on fixation clips

Secures the electrical bonding connection specifically between cable shelves in the steel trunking installation, Equipped with 6.3mm flat tab cable terminals on both sides and grip-on clips, green/yellow.

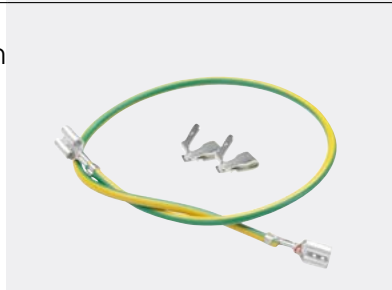

Ref.nr.	INS5510953
EAN Code	7321679004919

Earthing clamp cover

For earthing covers shorter than 100 mm. For 80 mm front cover.
Dimensions: 79/5/16.
Material: stainless steel.

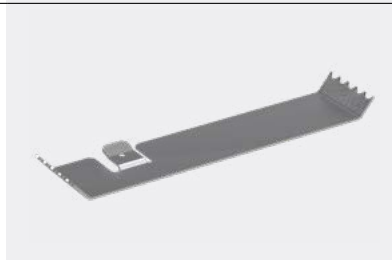

Ref.nr.	5590509
EAN Code	7315880098010

Wall bracket fixed High

Fixed depth wall brackets for mounting at a distance from the wall. High for trunking higher than 130 mm. Two self-drilling screws are included to each product. Material: Steel, unpainted.



Ref.nr.	INS55016	INS55036
EAN Code	3606489513610	3606489513627
Dimension	120/80/15 mm	120/80/35 mm

Wall brackets adjust High

Adjustable wall bracket for mounting of trunking at a distance from the wall. For trunking higher than 130 mm. Material: steel.



Ref.nr.	5583530	5583532	5583534
EAN Code	7315885583535	7315880078685	7315880078692
Dimension	102/126/50	102/126/70	102/126/110
Adjust between	50-70 mm	70-110 mm	110-170 mm
Ref.nr.	5583536		
EAN Code	7315880078708		
Dimension	102/126/160		
Adjust between	160-260 mm		



Ventilation rib holder

Ventilation rib holder. The ventilation rib installs securely with the included spring clip. Can be cut to length, and adjusted to the number of ventilation ribs installed. Two clips are included. The clip can be purchased as a spare part if lost. Dimension: 15/34/125 mm. Material: PLA plastic, halogen free.



Ref no	STA500057
EAN code	7321679003660

Ventilation rib

Allows the heat from the radiator to reach the window, and covers the gap between the wall/window and trunking. The trunking should never be installed above a radiator, regardless of material. Powder coated or natural anodized versions. Dimensions: 20/10/2500 mm. Material: aluminum.



Colour	<input type="radio"/> White RAL9003 <input type="radio"/> Black RAL9017
Ref no	STA500068 STA500069
EAN code	7321679003370 7321679003387

Ventilation rib jointing piece

Jointing piece for ventilation ribs. Grey color. Makes for a nicer installation, when joining two ventilation ribs in mid air. Installs from the bottom of the ventilation rib with a click. Dimension: 19/10/100 mm. Material: PLA plastic, halogen free.



Ref no	STA500070
EAN code	7321679003608

Ventilation rib clip

The clip secures the ventilation rib holder. Dimension: 38/22 Ø2 mm. Material: steel.



Ref no	STA500071
EAN code	7321679003400

Ventilation rib

Ventilation ribs. Dimension: 20/10/2500 mm. Material: steel.



Color	<input type="radio"/> White RAL9003 <input type="radio"/> White RAL9010 <input type="radio"/> Black RAL9017
Ref.nr.	STA550153 INS5590444 STA550152
EAN Code	8720871004717 8720871002652 8720871002751

One system
engineered from
the ground up





Stago WGX 170/65

Trunking Base

Steel trunking base with 80 mm front opening. Installs on wall or on fixed or adjustable brackets. Can be divided into compartments by cable shelves. Powder coated. Dimension: 170/65/3000 mm. Material: Steel.



Color	White RAL9010	Black RAL9017
Ref.nr.	INS5553003	STA550121
EAN Code	7315880080060	8720871002195

Inside Corner

Inside corner with 80 mm front opening. Can be divided into compartments by cable shelves. To be used with sheet steel front cover. Dimension: 170/65/200 mm. Material: Steel.

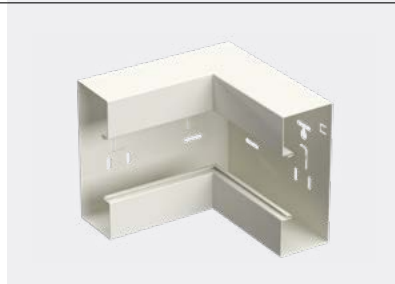

Color	White RAL9010	Black RAL9017
Ref.nr.	INS5553203	STA550119
EAN Code	7315880080244	8720871002171

Inside Corner adjust

Adjustable internal corner with 80 mm front opening. To be used to fit together two trunking bases that form a certain angle. Dimension: 170/65/115 mm. Material: Steel.

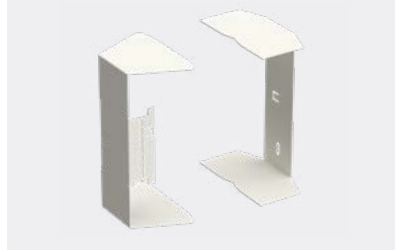

Color	White RAL9010	Black RAL9017
Ref.nr.	INS5553303	STA550124
EAN Code	7315880080305	8720871002225

Outside Corner kit

Outside corner with 80 mm front opening, kit including sheet steel front cover. Can be divided into compartments by cable shelves. Dimension: 170/65/200 mm. Material: Steel.

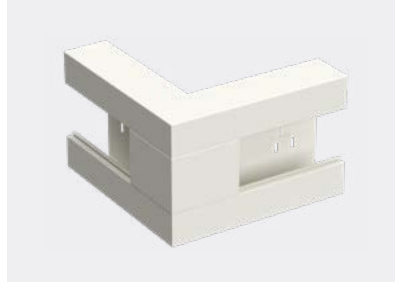

Color	White RAL9010	Black RAL9017
Ref.nr.	INS5553403	STA550123
EAN Code	7315880080183	872087100218

Universal Corner

Universal corner. Can be used both as internal and external corner. Dimension: 170/65 /145 mm. Material: Steel.



Color	White RAL9010	Black RAL9017
Ref.nr.	INS5553109	STA550118
EAN Code	7315880113706	8720871002164

L-piece kit rise/drop

90° bend with 80 mm front opening. Kit including sheet steel front cover of 225 mm length. Can be divided into compartments by cable shelves. Available as riser or dropper. Dimension: 250/65/250 mm. Material: Steel.



Color	White RAL9010	Black RAL9017
Ref.nr.	INS5553503	STA550122
EAN Code	7315880080367	8720871002201

T-piece kit

T-piece kit including sheet steel front cover. With 80 mm front opening and integrated flanges that must be bent up to a 90° angle before assembly. Can be divided into compartments by cable shelves. 170/65/400 mm. Material: Steel.

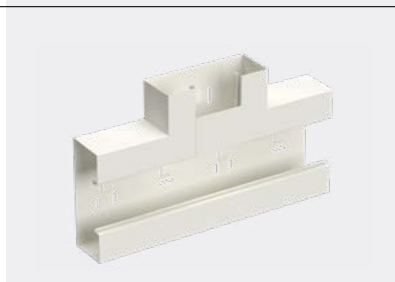

Color	White RAL9010	Black RAL9017
Ref.nr.	INS5553603	STA550120
EAN Code	3606480340468	8720871002188

End piece

Stop end intended to cover the ends of the trunking base. Dimension: 170/65/10 mm. Material: Steel.



Color	White RAL9010	Black RAL9017
Ref.nr.	INS5553803	STA550126
EAN Code	3606480340536	8720871002249

Cable shelf 65 mm single/double

Cable shelf, single or double, intended to divide the trunking into compartments. Material: Steel.



Shelf	Single	Double
Ref.nr.	INS5596100	INS5596110
EAN Code	7315885596108	7315885596115
Dimension	19/55/1500 mm	40/45/1500 mm

Front cover 80 mm

Front cover for the 80 mm front opening. The front cover guarantees equipotential bonding when installed in the trunking base. Dimension: 80/12.7/1500 mm. Material: steel.

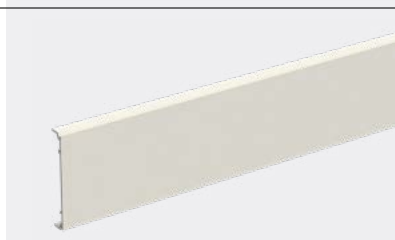

Color	White RAL9010	Black RAL9017
Ref.nr.	INS5596003	STA550154
EAN Code	7315880097990	8720871002706

Outlet front cover 100 mm

Outlet front cover kit including two front cover pieces, to be fitted on either side of socket outlets. Dimension: 80/12.7/100 mm. Material: steel.



Color	White RAL9010	Black RAL9017
ref nr	INS5596053	STA550155
EAN Code	3606480340789	8720871002713

Outlet front cover 50 mm

Outlet front cover kit including two front cover pieces, to be fitted on either side of socket outlets. Dimension: 80/12.7/50 mm. Material: steel.



Color	White RAL9010	Black RAL9017
ref nr	5595107	STA550156
EAN Code	7315880098089	8720871002720

Joining piece

Joining piece intended to joint trunking base parts together and connect them to earth. Provided with punched earthing clips. Dimension: 8/65/60 mm. Material: Stainless steel.



Color	Unpainted
Ref.nr.	INS5596240
EAN Code	7315880080640

Earth wire 300 mm

Secures the functional earth connection between the different components in the trunking installation. 300 mm long, 2.5mm². Equipped with 6.3mm flat tab cable terminals on both sides, green/yellow.



Ref.nr.	STA520086
EAN Code	7321679003738

Earthing wire incl. grip-on fixation clips

Secures the electrical bonding connection specifically between cable shelves in the steel trunking installation, Equipped with 6.3mm flat tab cable terminals on both sides and grip-on clips, green/yellow.



Ref.nr.	INS5510953
EAN Code	7321679004919

Earthing clamp cover

For earthing covers shorter than 100 mm. For 80 mm front cover. Dimensions: 79/5/16. Material: stainless steel.



Ref.nr.	5590509
EAN Code	7315880098010

Wall bracket fixed High

Fixed depth wall brackets for mounting at a distance from the wall. High for trunking higher than 130 mm. Two self-drilling screws are included to each product. Material: Steel, unpainted.



Ref.nr.	INS55016	INS55036
EAN Code	3606489513610	3606489513627
Dimension	120/80/15 mm	120/80/35 mm

Wall brackets adjust

Adjustable wall bracket for mounting of trunking at a distance from the wall. Suitable for steel trunking 120/65, 170/65, 170A/65.



Ref.nr.	5583550	5583552	5583554
EAN Code	7315885583559	7315880083931	7315880083948
Dimension	162/126/50	162/126/70	162/126/110
Adjust between	50-70 mm	70-110 mm	110-170 mm
Ref.nr.	5583556	5583558	
EAN Code	7315880083955	7315880083962	
Dimension	162/126/160	162/126/250	
Adjust between	160-260 mm	250-400 mm	

Ventilation rib holder

Ventilation rib holder. The ventilation rib installs securely with the included spring clip. Can be cut to length, and adjusted to the number of ventilation ribs installed. The clip can be purchased as a spare part if lost. Dimension: 15/34/125 mm. Material: PLA plastic, halogen free.



Ref no	STA500057
EAN code	7321679003660

Ventilation rib

Allows the heat from the radiator to reach the window, and covers the gap between the wall/window and trunking. The trunking should never be installed above a radiator, regardless of material. Powder coated or natural anodized versions. Dimensions: 20/10/2500 mm. Material: aluminum.



Colour	White RAL9003	Black RAL9017
Ref no	STA500068	STA500069
EAN code	7321679003370	7321679003387

Ventilation rib jointing piece

Jointing piece for ventilation ribs. Grey color. Makes for a nicer installation, when joining two ventilation ribs in mid air. Installs from the bottom of the ventilation rib with a click. Dimension: 19/10/100 mm. Material: PLA plastic, halogen free.



Ref no	STA500070
EAN code	7321679003608

Ventilation rib clip

The clip secures the ventilation rib holder. Dimension: 38/22 Ø2 mm. Material: steel.



Ref no	STA500071
EAN code	7321679003400

Ventilation rib

Ventilation ribs. Dimension: 20/10/2500 mm. Material: steel.



Color	White RAL9010	Black RAL9017
Ref.nr.	INS5590444	STA550152
EAN Code	8720871002652	8720871002751

Wall frame

Wall frame to be used to cover a trunking passage through the wall or to make an attractive finish of the trunking against a wall. Dimension: 220/90/10 mm. Material: PVC.



Color	White RAL9010	White RAL1013
Ref.nr.	INS19161770	INS19161700
EAN Code	8712186019265	8712186019258

Joint Cover piece

Joint cover piece, intended to cover joints between trunking sections. Dimension: 170/65/30 mm. Material: steel.



Color	White RAL9010	Black RAL9017
Ref.nr.	5595303	STA550125
EAN Code	7315880085232	8720871002232

Wall Frame

Wall frame to be used to cover a trunking passage through the wall or to make an attractive finish of the trunking against a wall. Dimension: 232/96/1.5 mm. Material: steel.

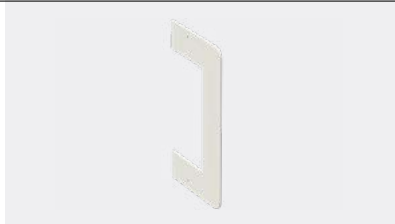

Color	White RAL9010	Black RAL9017
Ref.nr.	STA550185	STA550128
EAN Code	8720871002157	8720871002263

Saw support

Saw support/cutting jig for easy cutting of the trunking length. Dimension: 170/65/- Material: Wood.



Ref.nr.	INS5596231
EAN Code	7315880080626

Stago WGX 170A/65

Trunking Base

Steel trunking base with 80 mm front opening. Installs on wall or on fixed or adjustable brackets. Can be divided into compartments by cable shelves. Powder coated.
Dimension: 170/65/3000 mm.
Material: Steel.



Color	White RAL9010	Black RAL9017
Ref.nr.	INS5553013	STA550131
EAN Code	7315880080084	8720871002300

Inside Corner

Inside corner with 80 mm front opening. Can be divided into compartments by cable shelves. To be used with sheet steel front cover.
Dimension: 170/65/200 mm.
Material: Steel.



Color	White RAL9010	Black RAL9017
Ref.nr.	INS5553213	STA550129
EAN Code	7315880080268	8720871002287

Inside Corner adjust

Adjustable internal corner with 80 mm front opening. To be used to fit together two trunking bases that form a certain angle. Dimension: 170/65/115 mm. Material: Steel.

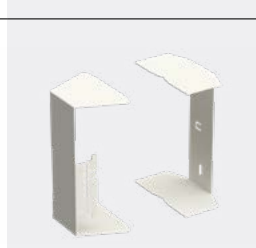

Color	White RAL9010	Black RAL9017
Ref.nr.	INS5553313	STA550137
EAN Code	7315880080329	8720871002362

Outside Corner kit

Outside corner with 80 mm front opening, kit including sheet steel front cover. Can be divided into compartments by cable shelves.
Dimension: 170/65/200 mm.
Material: Steel.

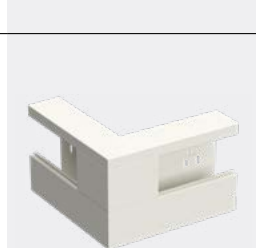

Color	White RAL9010	Black RAL9017
Ref.nr.	INS5553413	STA550136
EAN Code	7315880080206	8720871002355

Universal Corner

Universal corner. Can be used both as internal and external corner.
Dimension: 170/65/145 mm.
Material: Steel.



Color	White RAL9010	Black RAL9017
Ref.nr.	INS5553102	STA550138
EAN Code	7315880113676	8720871002379

L-piece kit dropper

90° bend with 80 mm front opening. Dropper. Kit including sheet steel front cover of 225 mm length. Can be divided into compartments by cable shelves. Dimension: 250/65/250 mm. Material: Steel.



Color	White RAL9010	Black RAL9017
Ref.nr.	INS5553519	STA550133
EAN Code	7315880080411	8720871002324

L-piece kit riser

90° bend with 80 mm front opening. Riser. Kit including sheet steel front cover of 225 mm length. Can be divided into compartments by cable shelves. Dimension: 250/65/250 mm. Material: Steel.



Color	White RAL9010	Black RAL9017
Ref.nr.	INS5553513	STA550132
EAN Code	7315880080381	8720871002317

T-piece kit

T-piece kit including sheet steel front cover. With 80 mm front opening and integrated flanges that must be bent up to a 90° angle before assembly. Can be divided into compartments by cable shelves. 170/65/400 mm. Material: Steel.



Color	White RAL9010	Black RAL9017
Ref.nr.	INS5553613	STA550130
EAN Code	3606480340475	8720871002294

Universal T-piece 120

Universal T-piece suitable for horizontal trunking 170A and vertical trunking 120 or 170, when used as a feeder. Dimension: 48/16/120 mm. Material: steel.



Color	White RAL9003	White RAL9010	Black RAL9017
Ref.nr.	STA550019	INS38050074	STA550086
EAN Code	'8720871001433	8712186108983	8720871001563

Universal T-piece 170

Universal T-piece suitable for horizontal trunking 170A and vertical trunking 120 or 170, when used as a feeder. Dimension: 48/16/120mm. Material: steel.

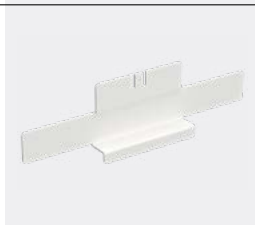

Color	White RAL9010	Black RAL9017
Ref.nr.	INS38051774	STA550151
EAN Code	8712186109102	8720871001037

Branching piece down asym

Asymmetrical branching piece, used for connection of feeder trunking 170x40 mm to the trunking base. Available as downward. Dimensions: 170/65/400 mm. Material: Steel.



Color	White RAL9010	Black RAL9017
Ref.nr.	INS5553719	STA550135
EAN Code	7315880080664	8720871002348

Branching Piece up asym

Asymmetrical branching piece, used for connection of feeder trunking 170x40 mm to the trunking base. Available as upward. Dimensions: 170/65/400 mm. Material: Steel.



Color	White RAL9010	Black RAL9017
Ref.nr.	INS5553713	STA550134
EAN Code	3606480340505	8720871002331

Cable shelf 65 mm single/double

Cable shelf, single or double, intended to divide the trunking into compartments. Material: Steel.





Shelf	Single	Double
Ref.nr.	INS5596100	INS5596110
EAN Code	7315885596108	7315885596115
Dimension	19/55/1500	40/45/1500

Front cover 80 mm

Front cover for the 80 mm front opening. The front cover guarantees equipotential bonding when installed in the trunking base. Dimension: 80/12.7/1500 mm. Material: steel.





		
Color	White RAL9010	Black RAL9017
Ref.nr.	INS5596003	STA550154
EAN Code	7315880097990	8720871002706

Outlet front cover 100 mm

Outlet front cover kit including two front cover pieces, to be fitted on either side of socket outlets. Dimension: 80/12.7/100 mm. Material: steel.





		
Color	White RAL9010	Black RAL9017
Ref.nr.	INS5596053	STA550155
EAN Code	3606480340789	8720871002713

Outlet front cover 50 mm

Outlet front cover kit including two front cover pieces, to be fitted on either side of socket outlets. Dimension: 80/12.7/50 mm. Material: steel.



		
Color	White RAL9010	Black RAL9017
Ref.nr.	5595107	STA550156
EAN Code	7315880098089	8720871002713

Jointing piece

Jointing piece intended to joint trunking base parts together and connect them to earth. Provided with punched earthing clips. Dimension: 8/65/60 mm. Material: steel.

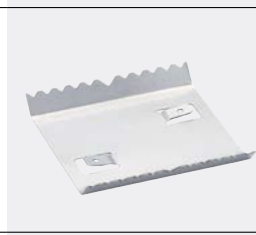

	
Color	Unpainted
Ref.nr.	INS5596240
EAN Code	7315880080640

Jointing piece

Jointing piece intended to joint trunking base parts together and connect them to earth. Provided with punched earthing clips. Dimension: 69/38/63 mm. Material: Steel.



	
Color	Unpainted
Ref.nr.	INS5596241
EAN Code	7315885596245

Earth wire 300 mm

Secures the functional earth connection between the different components in the trunking installation. 300 mm long, 2.5mm². Equipped with 6.3mm flat tab cable terminals on both sides, green/yellow.



	
Ref.nr.	STA520086
EAN Code	7321679003738

Earthing wire incl. grip-on fixation clips

Secures the electrical bonding connection specifically between cable shelves in the steel trunking installation, Equipped with 6.3mm flat tab cable terminals on both sides and grip-on clips, green/yellow.



	
Ref.nr.	INS5510953
EAN Code	7321679004919

Earthing clamp cover

For earthing covers shorter than 100 mm. For 80 mm front cover.
Dimensions: 79/5/16.
Material: stainless steel.

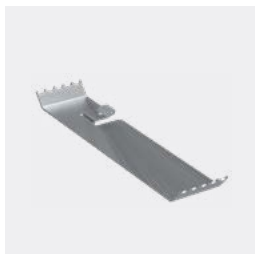

Ref.nr.	5590509
EAN Code	7315880098010

Wall bracket fixed High

Fixed depth wall brackets for mounting at a distance from the wall. High for trunking higher than 130 mm. Two self-drilling screws are included to each product. Material: Steel, unpainted.



Ref.nr.	INS55016	INS55036
EAN Code	3606489513610	3606489513627
Dimension	120/80/15 mm	120/80/35 mm

Wall brackets adjust

Adjustable wall bracket for mounting of trunking at a distance from the wall. Suitable for steel trunking 120/65, 170/65, 170A/65. Material: steel.



Ref.nr.	5583550	5583552	5583554
EAN Code	7315885583559	7315880083931	7315880083948
Dimension	162/126/50	162/126/70	162/126/110
Adjst between	50-70 mm	70-110 mm	110-170 mm
Ref.nr.	5583556	5583558	
EAN Code	7315880083955	7315880083962	
Dimension	162/126/160	162/126/250	
Adjst between	160-260 mm	250-400 mm	

Ventilation rib

Ventilation ribs.
Dimension: 20/10/2500 mm.
Material: steel.



Color	White RAL9010	Black RAL9017
Ref.nr.	INS5590444	STA550152
EAN Code	8720871002652	8720871002751

Wall frame

Wall frame to be used to cover a trunking passage through the wall or to make an attractive finish of the trunking against a wall. Dimension: 220/90/10 mm. Material: PVC.



Color	White RAL9010	White RAL9013
Ref.nr.	INS19161770	INS19161700
EAN Code	8712186019265	8712186019258

Wall Frame

Wall frame to be used to cover a trunking passage through the wall or to make an attractive finish of the trunking against a wall. Dimension: 220/90/10 mm. Material: steel.



Color	White RAL9010	Black RAL9017
Ref.nr.	STA550185	STA550128
EAN Code	8720871002157	8720871002263

Joint Cover piece

Joint cover piece, intended to cover joints between trunking sections. Dimension: 170/65/30 mm. Material: steel.



Color	White RAL9010	Black RAL9017
Ref.nr.	5595303	STA550125
EAN Code	7315880085232	8720871002232

Ventilation rib holder

Ventilation rib holder. The ventilation rib installs securely with the included spring clip. Can be cut to length, and adjusted to the number of ventilation ribs installed. Two clips are included. The clip can be purchased as a spare part if lost. Dimension: 15/34/125 mm. Material: PLA plastic, halogen free.



Ref no	● STA500057
EAN code	7321679003660

Ventilation rib

Allows the heat from the radiator to reach the window, and covers the gap between the wall/window and trunking. The trunking should never be installed above a radiator, regardless of material. Powder coated or natural anodized versions. Dimensions: 20/10/2500 mm. Material: aluminum.



Colour	○ White RAL9003	● Black RAL9017
Ref no	STA500068	STA500069
EAN code	7321679003370	7321679003387

Ventilation rib jointing piece

Jointing piece for ventilation ribs. Grey color. Makes for a nicer installation, when joining two ventilation ribs in mid air. Installs from the bottom of the ventilation rib with a click. Dimension: 19/10/100 mm. Material: PLA plastic, halogen free.



Ref no	● STA500070
EAN code	7321679003608

Ventilation rib clip

The clip secures the ventilation rib holder. Dimension: 38/22 Ø2 mm. Material: steel.



Ref no	● STA500071
EAN code	7321679003400

Saw support

Saw support/cutting jig for easy cutting of the trunking length. Dimension: 170A/65/- Material: Wood.

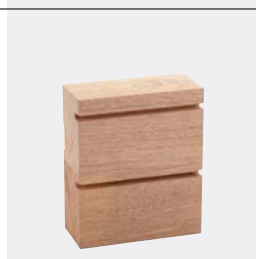

Ref.nr.	● INS5596232
EAN Code	7315880080633





Stago WGX 170A/72

Trunking Base

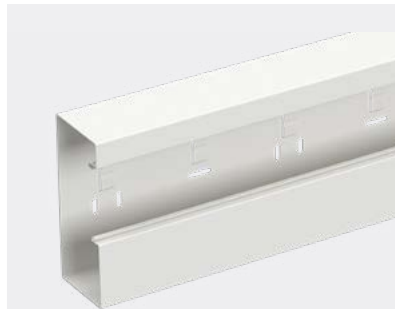
Steel trunking base with 80 mm front opening. Installs on wall or on fixed or adjustable brackets. Can be divided into compartments by cable shelves. Powder coated. Dimension: 170/72/2500 mm. Material: Steel.





			
Color	White RAL9003	White RAL9010	Black RAL9017
Ref.nr.	STA550055	INS5553023	STA550145
EAN Code	8720871002430	7315880081838	8720871002577

Inside Corner

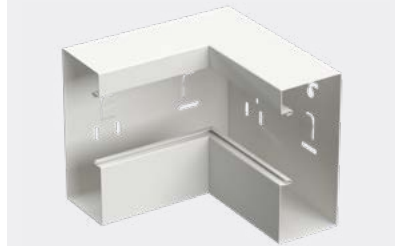
Inside corner with 80 mm front opening. Can be divided into compartments by cable shelves. To be used with sheet steel front cover. Dimension: 170/72/200 mm. Material: Steel.





			
Color	White RAL9003	White RAL9010	Black RAL9017
Ref.nr.	STA550056	INS5553223	STA550142
EAN Code	8720871002447	7315880081852	8720871002546

Outside Corner

Outside corner with 80 mm front opening, kit including sheet steel front cover. Can be divided into compartments by cable shelves. Dimension: 170/72/200 mm. Material: Steel.





			
Color	White RAL9003	White RAL9010	Black RAL9017
Ref.nr.	STA550057	INS5553423	STA550148
EAN Code	8720871002454	7315880081876	8720871002607

Universal Corner

Universal corner. Can be used both as internal and external corner. Dimension: 170/72 /150 mm. Material: Steel.





			
Color	White RAL9003	White RAL9010	Black RAL9017
Ref.nr.	STA550051	INS5553123	STA550141
EAN Code	8720871002393	7315885553125	8720871002591

L-piece kit dropper

90° bend with 80 mm front opening. Dropper. Kit including sheet steel front cover of 225 mm length. Can be divided into compartments by cable shelves. Dimension: 250/72/250 mm. Material: Steel.



			
Color	White RAL9003	White RAL9010	Black RAL9017
Ref.nr.	STA550059	INS5553525	STA550147
EAN Code	8720871002478	7315880081913	8720871002591

L-piece kit riser

90° bend with 80 mm front opening. Riser. Kit including sheet steel front cover of 225 mm length. Can be divided into compartments by cable shelves. Dimension: 250/72/250 mm. Material: Steel.



Color	White RAL9003	White RAL9010	Black RAL9017
Ref.nr.	STA550058	INS5553523	STA550146
EAN Code	8720871002461	7315880081890	8720871002584

T-piece dropper

T-piece with 80 mm front opening and integrated flanges that must be bent up to a 90° angle before assembly. Dropper. Can be divided into compartments by cable shelves. To be used with sheet steel front cover. Dimension: 170/72/400 mm. Material: Steel.



Color	White RAL9003	White RAL9010	Black RAL9017
Ref.nr.	STA550053	STA550176	STA550144
EAN Code	8720871002416	8720871002508	8720871002560

T-piece riser

T-piece with 80 mm front opening and integrated flanges that must be bent up to a 90° angle before assembly. Riser. Can be divided into compartments by cable shelves. To be used with sheet steel front cover. Dimension: 170/72/400 mm. Material: Steel.

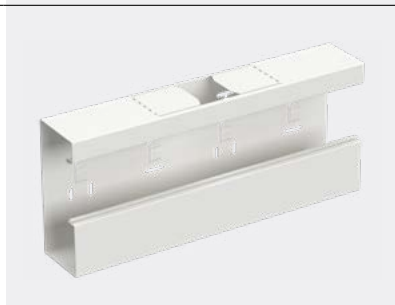

Color	White RAL9003	White RAL9010	Black RAL9017
Ref.nr.	STA550052	INS5553623	STA550143
EAN Code	8720871002409	3606480340482	8720871002553

End piece

Stop end intended to cover the ends of the trunking base. Dimension: 170/72/11 mm. Material: Steel.



Color	White RAL9003	White RAL9010	Black RAL9017
Ref.nr.	STA550060	INS5553813	STA550150
EAN Code	8720871002485	3606480340543	8720871002621

Cable shelf single 72 mm

Single cable shelf, intended to divide the trunking into compartments. Dimension: 27/60/1000 mm. Material: steel.



Material	Steel
Ref.nr.	5591740
EAN Code	7315885591745

Cable shelf double 72 mm

Cable shelf, double, intended to divide the trunking into compartments. Dimension (steel): 41/52/1000 mm. Dimension (PVC): 49/61/500 mm.

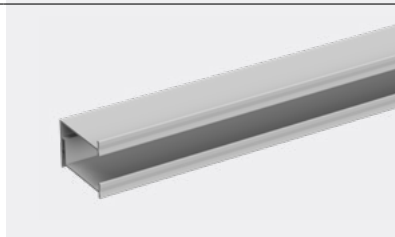

Material	Steel	PVC
Ref.nr.	5591743	5591720
EAN Code	7315880113362	7315885591721

Front cover 80 mm

Front cover for the 80 mm front opening. The front cover guarantees equipotential bonding when installed in the trunking base. Dimension: 80/12.7/1500 mm. Material: steel.

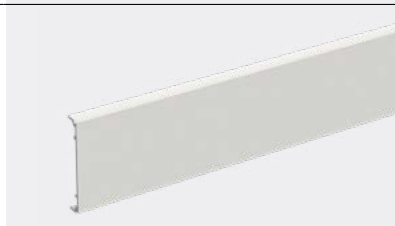

Color	White RAL9003	White RAL9010	Black RAL9017
Ref.nr.	STA550066	INS5596003	STA550154
EAN Code	8720871002683	7315880097990	8720871002706

Outlet front cover 100 mm

Outlet front cover kit including two front cover pieces, to be fitted on either side of socket outlets. Dimension: 80/12.7/100 mm. Material: steel.





Color	White RAL9003	White RAL9010	Black RAL9017
Ref.nr.	STA550065	INS5596053	STA550155
EAN Code	8720871002676	3606480340789	8720871002713

Outlet front cover 50 mm

Outlet front cover kit including two front cover pieces, to be fitted on either side of socket outlets. Dimension: 80/12.7/50 mm. Material: steel.



			
Color	White RAL9003	White RAL9010	Black RAL9017
Ref.nr.	STA550067	5595107	STA550156
EAN Code	8720871002690	7315880098089	8720871002720

Jointing piece

Joint piece, intended to joint trunking base parts together and connect them to earth between trunking sections. Dimension: 60/71/7 mm. Material: steel.



Ref.nr.	 5590935
EAN Code	7315880066026

Earth wire 300 mm

Secures the functional earth connection between the different components in the trunking installation. 300 mm long, 2.5mm². Equipped with 6.3mm flat tab cable terminals on both sides, green/yellow.



Ref.nr.	 STA520086
EAN Code	7321679003738

Earthing wire incl. grip-on fixation clips

Secures the electrical bonding connection specifically between cable shelves in the steel trunking installation, Equipped with 6.3mm flat tab cable terminals on both sides and grip-on clips, green/yellow.

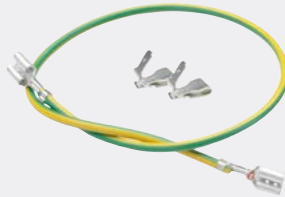

Ref.nr.	 INS5510953
EAN Code	7321679004919

Earthing clamp cover

For earthing covers shorter than 100 mm. For 80 mm front cover. Dimensions: 79/5/16. Material: stainless steel.





Ref.nr.	 5590509
EAN Code	7315880098010

Wall bracket fixed High

Fixed depth wall brackets for mounting at a distance from the wall. High for trunking higher than 130 mm. Two self-drilling screws are included to each product. Material: Steel, unpainted.







		
Ref.nr.	INS55016	INS55036
EAN Code	3606489513610	3606489513627
Dimension	120/80/15 mm	120/80/35 mm

Wall brackets adjust High

Adjustable wall bracket for mounting of trunking at a distance from the wall. For trunking higher than 130 mm. Material: steel.



		
Ref.nr.	5583530	5583532
EAN Code	7315885583535	7315880078685
Dimension	102/126/50	102/126/70
Adjst between	50-70 mm	70-110 mm
		
Ref.nr.	5583534	5583536
EAN Code	7315880078692	7315880078708
Dimension	102/126/110	102/126/160
Adjst between	110-170 mm	160-260 mm

Ventilation rib holder

Ventilation rib holder. The ventilation rib installs securely with the included spring clip. Can be cut to length, and adjusted to the number of ventilation ribs installed. Two clips are included. The clip can be purchased as a spare part if lost. Dimension: 15/34/125 mm. Material: PLA plastic, halogen free.



Ref no	STA500057
EAN code	7321679003660

Ventilation rib

Allows the heat from the radiator to reach the window, and covers the gap between the wall/window and trunking. The trunking should never be installed above a radiator, regardless of material. Powder coated or natural anodized versions. Dimensions: 20/10/2500 mm. Material: aluminum.



Colour	White RAL9003	Black RAL9017
Ref no	STA500068	STA500069
EAN code	7321679003370	7321679003357

Ventilation rib jointing piece

Jointing piece for ventilation ribs. Grey color. Makes for a nicer installation, when joining two ventilation ribs in mid air. Installs from the bottom of the ventilation rib with a click. Dimension: 19/10/100 mm. Material: PLA plastic, halogen free.



Ref no	STA500070
EAN code	7321679003608

Ventilation rib clip

The clip secures the ventilation rib holder. Dimension: 38/22 02 mm. Material: steel.



Ref no	STA500071
EAN code	7321679003400

Ventilation rib

Ventilation ribs. Dimension: 20/10/2500 mm. Material: steel.



Color	White RAL9003	White RAL9010	Black RAL9017
Ref.nr.	STA550153	INS5590444	STA550152
EAN Code	8720871004717	8720871002652	8720871002751

Joint Cover piece

Joint cover piece, intended to cover joints between trunking sections. Dimension: 170/72/30 mm. Material: steel.



Color	White RAL9003	White RAL9010	Black RAL9017
Ref.nr.	STA550061	5595308	STA550149
EAN Code	8720871002492	7315880085270	8720871002614

Wall Frame

Wall frame to be used to cover a trunking passage through the wall or to make an attractive finish of the trunking against a wall. Dimension: 232/102/1.5 mm. Material: steel.

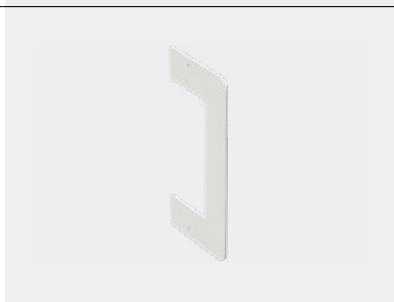

Color	White RAL9003	White RAL9010	Black RAL9017
Ref.nr.	STA550054	STA550187	STA550140
EAN Code	8720871002423	8720871002515	8720871002522

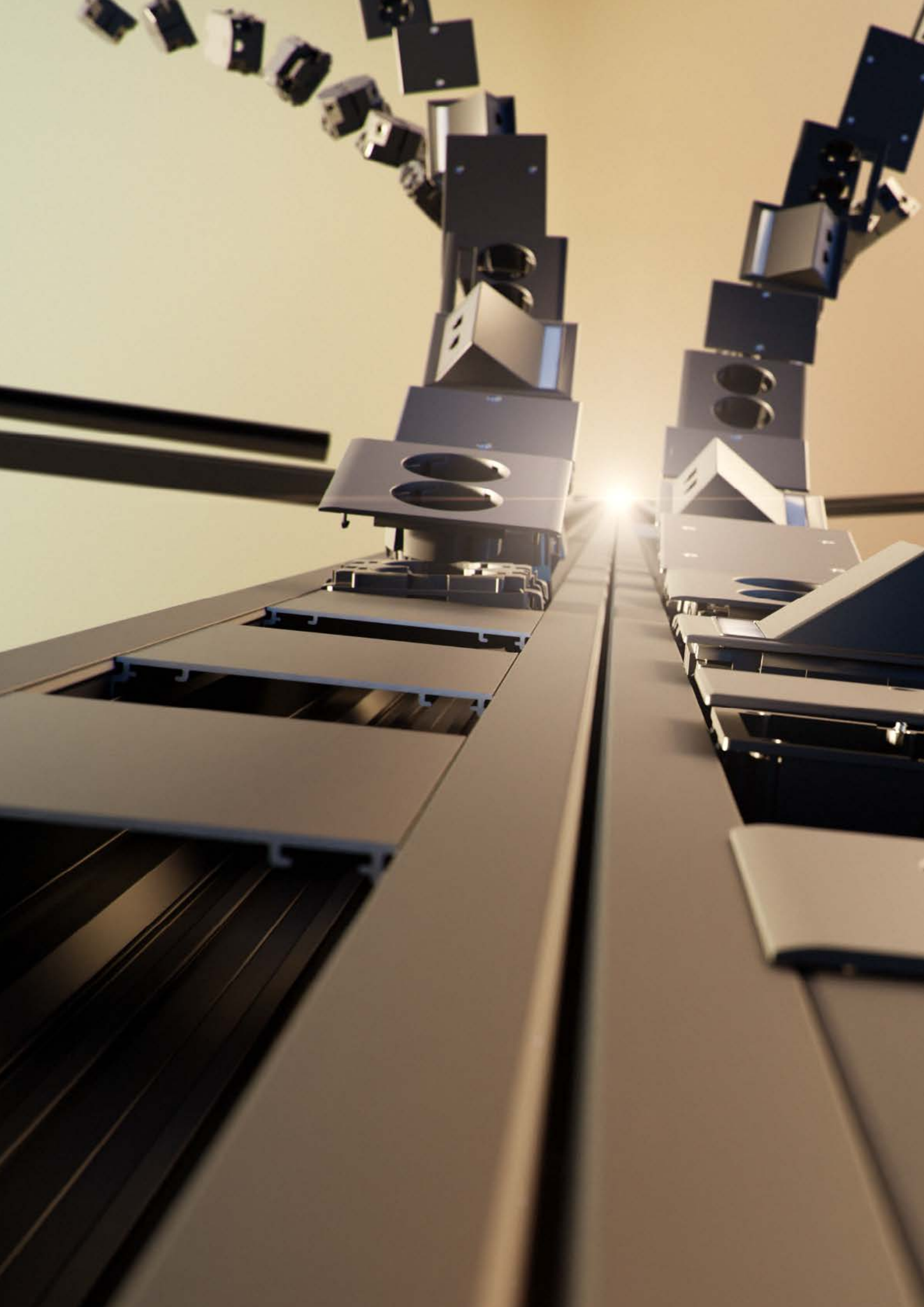



One provider,
moving the
industry forward

Stago WGX 183/72

Trunking Base

Steel trunking base with 40 and 80 mm front opening. Installs on wall or on fixed or adjustable brackets. Can be divided into compartments by cable shelves. Powder coated.
Dimension: 183/72/2500 mm.
Material: Steel.

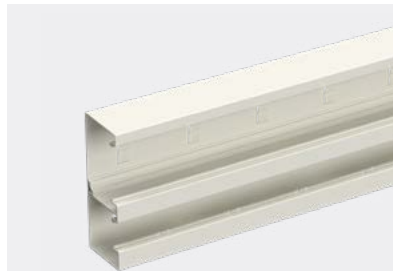

Color	White RAL9010
Ref.nr.	INS5555003
EAN Code	7315880082231

Inside Corner

Inside corner with 40 mm and 80 mm front opening. Can be divided into compartments by cable shelves. Integrated and removable partition wall included. To be used with sheet steel front cover.
Dimension: 183/72/200 mm.
Material: Steel.

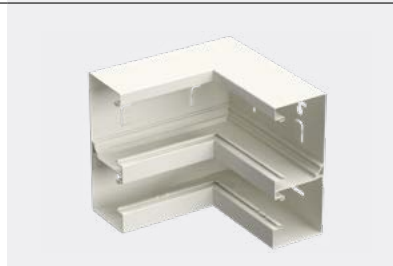

Color	White RAL9010
Ref.nr.	INS5555203
EAN Code	7315880082255

Outside Corner

Outside corner with 40 mm and 80 mm front opening, kit including sheet steel front cover. Can be divided into compartments by cable shelves. Integrated and removable partition wall included.
Dimension: 183/72/200 mm.
Material: Steel.



Color	White RAL9010
Ref.nr.	INS5555403
EAN Code	7315880082279

L-piece kit dropper

90° bend with 40 mm and 80 mm front opening. Dropper. Kit including sheet steel front cover of 225 mm length. Can be divided into compartments by cable shelves. Integrated and removable partition wall included.
Dimension: 250/72/250 mm.
Material: Steel.

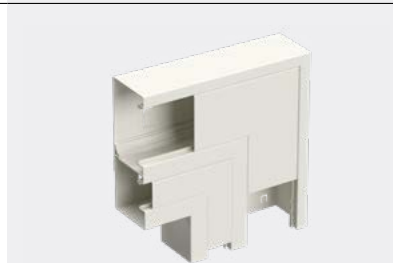

Color	White RAL9010
Ref.nr.	INS5555505
EAN Code	3606480340727

L-piece kit riser

90° bend with 40 mm and 80 mm front opening. Riser. Kit including sheet steel front cover of 225 mm length. Can be divided into compartments by cable shelves. Integrated and removable partition wall included. Dimension: 250/72/250 mm.
Material: Steel.



Color	White RAL9010
Ref.nr.	INS5555503
EAN Code	3606480340710

T-piece riser

T-piece with 40 mm and 80 mm front opening and integrated flanges that must be bent up to a 90° angle before assembly. Dropper. Can be divided into compartments by cable shelves. Integrated and removable partition wall, provided with pre-punched holes, included. To be used with sheet steel front cover. Dimension: 183/72/400 mm. Material: Steel.



Color	White RAL9010
Ref.nr.	INS5555603
EAN Code	7315880082347

End piece

Stop end intended to cover the ends of the trunking base. Dimension: 183/72/11 mm. Material: Steel.



Color	White RAL9010
Ref.nr.	INS5555803
EAN Code	3606480340758

Cable shelf single 72 mm

Single cable shelf, intended to divide the trunking into compartments. Dimension: 27/60/1000 mm. Material: steel.



Material	Steel
Ref.nr.	5591740
EAN Code	7315885591745

Cable shelf double 72 mm

Cable shelf, double, intended to divide the trunking into compartments. Dimension (steel): 41/52/1000 mm. Dimension (PVC): 49/61/500 mm.

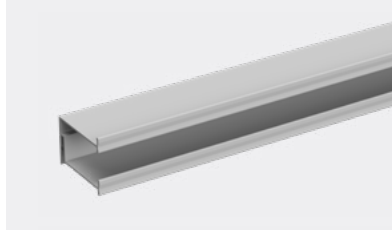

Material	Steel	PVC
Ref.nr.	5591743	5591720
EAN Code	7315880113362	7315885591721

Front cover 40 mm

Front cover for the 40 mm front opening. The front cover guarantees equipotential bonding when installed in the trunking base. Dimension: 40/12.7/1500 mm. Material: Steel.

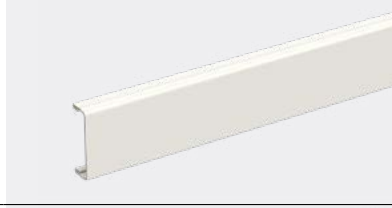

Color	White RAL9010
Ref.nr.	INS5596019
EAN Code	7315880098164

Front cover 80 mm

Front cover for the 80 mm front opening. The front cover guarantees equipotential bonding when installed in the trunking base. Dimension: 80/12.7/1500 mm. Material: steel.

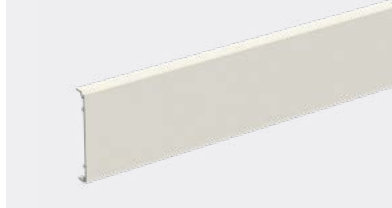

Color	White RAL9010
Ref.nr.	INS5596003
EAN Code	7315880097990

Outlet front cover 100 mm

Outlet front cover kit including two front cover pieces, to be fitted on either side of socket outlets. Dimension: 80/12.7/100 mm. Material: steel.



Color	White RAL9010
Ref.nr.	INS5596053
EAN Code	3606480340789

Outlet front cover 50 mm

Outlet front cover kit including two front cover pieces, to be fitted on either side of socket outlets. Dimension: 80/12.7/50 mm. Material: steel.



Color	White RAL9010
Ref.nr.	5595107
EAN Code	7315880098089

Jointing piece

Joint piece, intended to joint trunking base parts together and connect them to earth between trunking sections. Dimension: 60/71/7 mm. Material: steel.



Ref.nr.	5590935
EAN Code	7315880066026

Earth wire 300 mm

Secures the functional earth connection between the different components in the trunking installation. 300 mm long, 2.5mm². Equipped with 6.3mm flat tab cable terminals on both sides, green/yellow.



Ref.nr. STA520086
EAN Code 7321679003738

Earthing wire incl. grip-on fixation clips

Secures the electrical bonding connection specifically between cable shelves in the steel trunking installation, Equipped with 6.3mm flat tab cable terminals on both sides and grip-on clips, green/yellow.



Ref.nr. INS5510953
EAN Code 7321679004919

Earthing clamp cover

For earthing covers shorter than 100 mm. For 40 or 80 mm front cover. Dimension: 79/5/16 mm. Material: stainless steel.



Ref.nr.	INS5590508	5590509
EAN Code	7315880098027	7315880098010
Size	F40	80 mm

Wall bracket fixed High

Fixed depth wall brackets for mounting at a distance from the wall. High for trunking higher than 130 mm. Two self-drilling screws are included to each product. Material: Steel, unpainted.



Ref.nr.	INS55016	INS55036
EAN Code	73606489513610	3606489513627
Dimension	120/80/15 mm	120/80/35 mm

Wall brackets adjust High

Adjustable wall bracket for mounting of trunking at a distance from the wall. For trunking higher than 130 mm. Material: steel.



Ref.nr.	5583530	5583532
EAN Code	7315885583535	7315880078685
Dimension	102/126/50	102/126/70
Adjst between	50-70 mm	70-110 mm

Ref.nr.	5583534	5583536
EAN Code	7315880078692	7315880078708
Dimension	102/126/110	102/126/160
Adjst between	110-170 mm	160-260 mm

Ventilation rib holder

Ventilation rib holder. The ventilation rib installs securely with the included spring clip. Can be cut to length, and adjusted to the number of ventilation ribs installed. Two clips are included. The clip can be purchased as a spare part if lost. Dimension: 15/34/125 mm. Material: PLA plastic, halogen free.

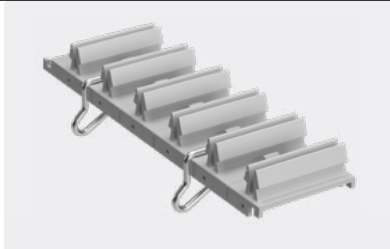

Ref no STA500057
EAN code 7321679003660

Ventilation rib

Allows the heat from the radiator to reach the window, and covers the gap between the wall/window and trunking. The trunking should never be installed above a radiator, regardless of material. Powder coated or natural anodized versions. Dimensions: 20/10/2500 mm. Material: aluminum.

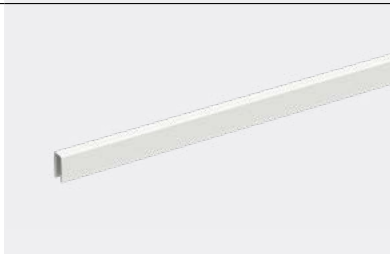

Colour	White RAL9003	Black RAL9017
Ref no	STA500068	STA500069
EAN code	7321679003370	7321679003387

Ventilation rib jointing piece

Jointing piece for ventilation ribs. Grey color. Makes for a nicer installation, when joining two ventilation ribs in mid air. Installs from the bottom of the ventilation rib with a click. Dimension: 19/10/100 mm. Material: PLA plastic, halogen free.



Ref no STA500070
 EAN code 7321679003608

Ventilation rib clip

The clip secures the ventilation rib holder. Dimension: 38/22 Ø2 mm. Material: steel.



Ref no STA500071
 EAN code 7321679003400

Ventilation rib

Ventilation ribs. Dimension: 20/10/2500 mm. Material: steel.



Color White RAL9010
 Ref.nr. INS5590444
 EAN Code 8720871002652

Joint Cover piece

Joint cover piece, intended to cover joints between trunking sections. Dimension: 183/72/30 mm. Material: steel.

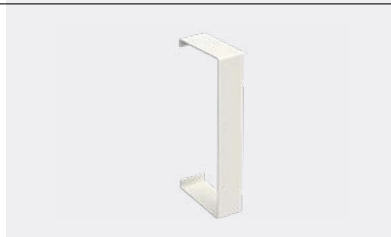

Color White RAL9010
 Ref.nr. 5595323
 EAN Code 7315880085331

Earth terminal

Earth terminal for earthing of front cover. Installation by simply twisting into the 80 mm front cover. Use in combination with earthing wire. Material: electroplated steel.



Ref no STA520098
 EAN code 7321679003752

Stago WGX 233/72

Trunking Base

Steel trunking base with 80 mm front opening. Installs on wall or on fixed or adjustable brackets. Can be divided into compartments by cable shelves. Powder coated. Dimension: 233/72/2500 mm. Material: Steel.



Color	White RAL9010
Ref.nr.	INS5558003
EAN Code	7315880082989

Inside Corner

Inside corner with 80 mm front opening. Can be divided into compartments by cable shelves. Integrated and removable partition wall included. To be used with sheet steel front cover. Dimension: 233/72/200 mm. Material: Steel.



Color	White RAL9010
Ref.nr.	INS5558203
EAN Code	7315880083009

Outside Corner

Outside corner with 80 mm front opening, kit including sheet steel front cover. Can be divided into compartments by cable shelves. Integrated and removable partition wall included. Dimension: 233/72/200 mm. Material: Steel.



Color	White RAL9010
Ref.nr.	INS5558403
EAN Code	7315880083023

L-piece kit dropper

90° bend with 80 mm front opening. Dropper. Kit including sheet steel front cover of 225 mm length. Can be divided into compartments by cable shelves. Integrated and removable partition wall included. Dimension: 300/72/300 mm. Material: Steel.

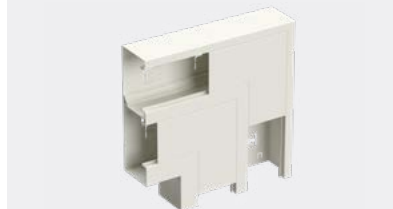

Color	White RAL9010
Ref.nr.	STA550169
EAN Code	8720871002638

L-piece kit riser

90° bend with 80 mm front opening. Dropper. Kit including sheet steel front cover of 225 mm length. Can be divided into compartments by cable shelves. Integrated and removable partition wall included. Dimension: 300/72/300 mm. Material: Steel.



Color	White RAL9010
Ref.nr.	INS5558503
EAN Code	7315880083047

T-piece riser

T-piece with 80 mm front opening and integrated flanges that must be bent up to a 90° angle before assembly. Dropper. Can be divided into compartments by cable shelves. Integrated and removable partition wall, provided with pre-punched holes, included. To be used with sheet steel front cover. Dimension: 233/72/400 mm. Material: Steel.

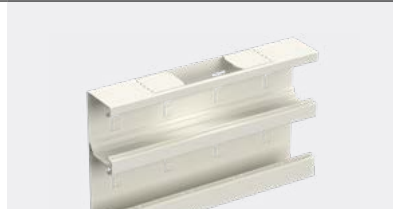

Color	White RAL9010
Ref.nr.	INS5558603
EAN Code	7315880083092

End piece

Stop end intended to cover the ends of the trunking base. Dimension: 233/72/11 mm.
Material: Steel.



Color	White RAL9010
Ref.nr.	INS5558803
EAN Code	7315880083160

Cable shelf single 72 mm

Single cable shelf, intended to divide the trunking into compartments.
Dimension: 27/60/1000 mm.
Material: steel.

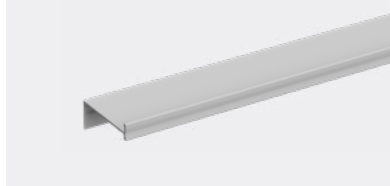

Material	Steel
Ref.nr.	5591740
EAN Code	7315885591745

Cable shelf double 72 mm

Cable shelf, double, intended to divide the trunking into compartments.
Dimension (steel): 41/52/1000 mm.
Dimension (PVC): 49/61/500 mm.

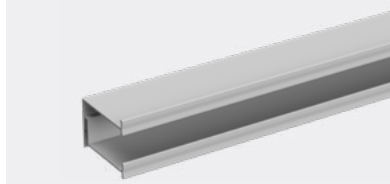

Material	Steel	PVC
Ref.nr.	5591743	5591720
EAN Code	7315880113362	7315885591721

Front cover 80 mm

Front cover for the 80 mm front opening. The front cover guarantees equipotential bonding when installed in the trunking base.
Dimension: 80/12.7/1500 mm. Material: steel.



Color	White RAL9010
Ref.nr.	INS5596003
EAN Code	7315880097990

Outlet front cover 100 mm

Outlet front cover kit including two front cover pieces, to be fitted on either side of socket outlets.
Dimension: 80/12.7/100 mm. Material: steel.



Color	White RAL9010
Ref.nr.	INS5596053
EAN Code	3606480340789

Outlet front cover 50 mm

Outlet front cover kit including two front cover pieces, to be fitted on either side of socket outlets.
Dimension: 80/12.7/50 mm. Material: steel.



Color	White RAL9010
Ref.nr.	5595107
EAN Code	7315880098089

Joining piece

Joint piece, intended to joint trunking base parts together and connect them to earth between trunking sections.
Dimension: 60/71/7 mm. Material: steel.

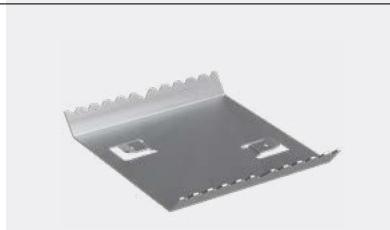

Ref.nr.	5590935
EAN Code	7315880066026

Earth wire 300 mm

Secures the functional earth connection between the different components in the trunking installation. 300 mm long, 2.5mm². Equipped with 6.3mm flat tab cable terminals on both sides, green/yellow.



Ref.nr.	STA520086
EAN Code	7321679003738

Earthing wire incl. grip-on fixation clips

Secures the electrical bonding connection specifically between cable shelves in the steel trunking installation. Equipped with 6.3mm flat tab cable terminals on both sides and grip-on clips, green/yellow.



Ref.nr.	INS5510953
EAN Code	7321679004919

Earthing clamp cover

For earthing covers shorter than 100 mm. For 80 mm front cover.
Dimensions: 79/5/16. Material: stainless steel.



Ref.nr.	5590509
EAN Code	7315880098010

Wall bracket fixed High

Fixed depth wall brackets for mounting at a distance from the wall. High for trunking higher than 130 mm. Two self-drilling screws are included to each product. Material: Steel, unpainted.

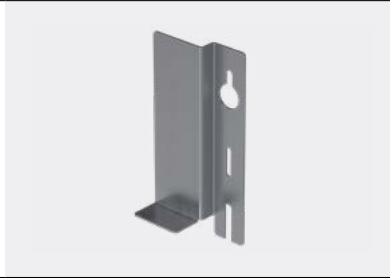

Ref.nr.	INS55016	INS55036
EAN Code	3606489513610	3606489513627
Dimension	120/80/15 mm	120/80/35 mm

Wall brackets adjust High

Adjustable wall bracket for mounting of trunking at a distance from the wall. For trunking higher than 130 mm. Material: steel.



Ref.nr.	5583530	5583532
EAN Code	7315885583535	7315880078685
Dimension	102/126/50	102/126/70
Adjst between	50-70 mm	70-110 mm
Ref.nr.	5583534	5583536
EAN Code	7315880078692	7315880078708
Dimension	102/126/110	102/126/160
Adjst between	110-170 mm	160-260 mm

Ventilation rib holder

Ventilation rib holder. The ventilation rib installs securely with the included spring clip. Can be cut to length, and adjusted to the number of ventilation ribs installed. Two clips are included. The clip can be purchased as a spare part if lost. Dimension: 15/34/125 mm. Material: PLA plastic, halogen free.

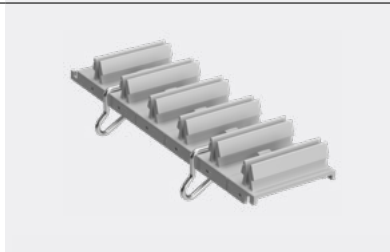

Ref no	STA500057
EAN code	7321679003660

Ventilation rib

Allows the heat from the radiator to reach the window, and covers the gap between the wall/window and trunking. The trunking should never be installed above a radiator, regardless of material. Powder coated or natural anodized versions. Dimensions: 20/10/2500 mm. Material: aluminum.

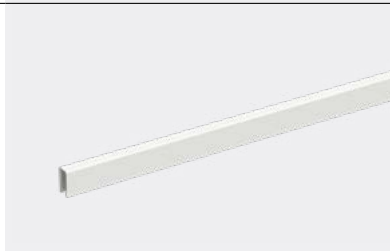

Colour	White RAL9003	Black RAL9017
Ref no	STA500068	STA500069
EAN code	7321679003370	7321679003387

Ventilation rib jointing piece

Jointing piece for ventilation ribs. Grey color. Makes for a nicer installation, when joining two ventilation ribs in mid air. Installs from the bottom of the ventilation rib with a click. Dimension: 19/10/100 mm. Material: PLA plastic, halogen free.



Ref no	STA500070
EAN code	7321679003608

Ventilation rib clip

The clip secures the ventilation rib holder. Dimension: 38/22 Ø2 mm. Material: steel.



Ref no	STA500071
EAN code	7321679003400

Ventilation rib

Ventilation ribs. Dimension: 20/10/2500 mm.
Material: steel.



Color	White RAL9010
Ref.nr.	INS5590444
EAN Code	8720871002652

Joint Cover piece

Joint cover piece, intended to cover joints between trunking sections. Dimension: 233/72/30 mm.
Material: steel.



Color	White RAL9010
Ref.nr.	5595383
EAN Code	7315880085461

Earth terminal

Earth terminal for earthing of front cover. Installation by simply twisting into the 80 mm front cover. Use in combination with earthing wire.
Material: electroplated steel.



Ref no	STA520098
EAN code	7321679003752

Technical data

Standards	The products comply with the standards:
	EN 50085-1 & IEC 61084-1
	EN 50085-2/1 & IEC 61084-2/1
	"The products satisfy the provisions for CE marking according to the Low Voltage Directive 2014/35/EU."
	"The products comply with the RoHS directive 2011/65 EU, REACH Directive 2006/1907 EU (Restriction of Hazardous Substances)"
	KEMA KEUR certificate Number 71-123577 REV.1

Material data

Material	Pre-galvanized sheet steel in accordance with EN 10346
Density	7,646 g/cm ³
Linear expansion	11.5x10 ⁻⁶ /°C
Surface treatment	Zinc coating, Powder coated
Color spec	White RAL9003
	White RAL9010
	White RAL 1013
	Black RAL9017
	Optional acc. to customer requirement

Operative data

Temperature range	From -25°C to +60°C
Suitable outdoors	No
Degree of protection	IP20
Suitable for environmental, Corrosion Class According to ISO 12944-2	C1, C2
Impedance of ducting length or trunking length	3,3 mΩ/m
Trunking access cover retention	Access cover can only be opened with a tool.
Non reusable fasteners	Earth terminal for 80 mm and 40 mm front cover (STA520098)
	Earthing grip (INS5510953)

Cable capacity

110/52

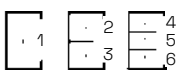

Comp. Diameter No. of wire Cross section area mm² Cable capacity mm²

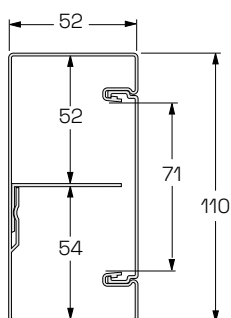

Cable No.	Comp. Diameter No. of wire	Cross section area mm ²	Cable capacity mm ²		
			40%	50%	60%
Without mounting boxes					
1	37	4152	1661	2076	2491
2	39	2052	821	1026	1231
3	37	2131	852	1066	1279
4	31	1302	521	651	781
5	29	1027	411	513	616
6	31	1354	542	677	812
With 50 mm deep sockets					
1	19	1723	689	862	1034
2	19	776	310	388	465
3	19	948	379	474	569
4	19	776	310	388	465
5	0	0	-	-	-
6	19	944	377	472	566

Cable No.	Comp. Diameter No. of wire	Cross section area mm ²	Cable capacity mm ²		
			40%	50%	60%
With 45 mm deep sockets					
1	19	1892	727	965	1135
2	19	887	355	443	532
3	19	1000	400	500	600
4	19	821	328	410	492
5	5	150	60	75	90
6	19	902	361	451	541

Cable No.	Comp. Diameter No. of wire	Cross section area mm ²	Cable capacity mm ²		
			40%	50%	60%
With 23 mm deep sockets					
1	37	3980	1592	1990	2388
2	29	1904	761	952	1142
3	29	2045	818	1022	1227
4	29	1350	540	675	810
5	29	1027	411	513	616
6	29	1201	481	601	721

120/65

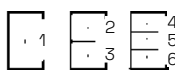

Comp. Diameter No. of wire Cross section area mm² Cable capacity mm²

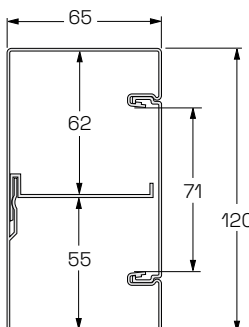

Cable No.	Comp. Diameter No. of wire	Cross section area mm ²	Cable capacity mm ²		
			40%	50%	60%
Without mounting boxes					
1	50	6082	2433	3041	3649
2	50	3153	1261	1576	1892
3	50	2926	1171	1463	1756
4	44	2002	801	1001	1201
5	33	1432	573	716	859
6	37	2108	843	1054	1265
With 50 mm deep sockets					
1	27	3693	1477	1846	2216
2	27	1693	677	846	1016
3	27	1909	763	954	1145
4	27	1555	622	778	993
5	12	427	171	213	256
6	27	1683	5673	841	1010

Cable No.	Comp. Diameter No. of wire	Cross section area mm ²	Cable capacity mm ²		
			40%	50%	60%
With 45 mm deep sockets					
1	26	3831	1532	1915	2298
2	26	1781	712	890	1068
3	26	1955	782	978	1173
4	26	1563	625	781	938
5	16	580	232	290	348
6	26	1654	662	827	992

Cable No.	Comp. Diameter No. of wire	Cross section area mm ²	Cable capacity mm ²		
			40%	50%	60%
With 23 mm deep sockets					
1	49	5924	2369	2962	3554
2	41	2964	1185	1482	1778
3	41	2840	1136	1420	1704
4	41	2090	836	1045	1254
5	33	1432	573	716	859
6	37	1976	790	988	1186

110/72

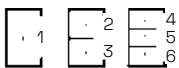

Comp. Diameter No. of wire Cross section area mm² Cable capacity mm²

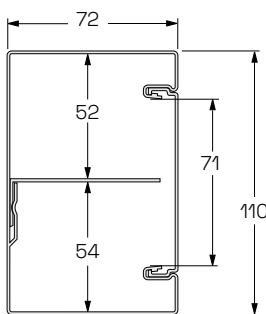

Cable No.	Comp. Diameter No. of wire	Cross section area mm ²	Cable capacity mm ²		
			40%	50%	60%
Without mounting boxes					
1	53	6155	2462	3078	3693
2	51	2939	1176	1470	1763
3	52	3080	1232	1540	1848
4	33	2018	807	1009	1211
5	30	1682	673	841	1009
6	30	1976	790	988	1186
With 50 mm deep sockets					
1	27	3603	1441	1802	2162
2	27	1733	693	867	1040
3	27	1827	731	914	1096
4	27	1448	579	724	869
5	16	554	222	277	332
6	27	1439	576	720	863

Cable No.	Comp. Diameter No. of wire	Cross section area mm ²	Cable capacity mm ²		
			40%	50%	60%
With 45 mm deep sockets					
1	25	3784	1514	1892	2270
2	25	1814	726	907	1088
3	25	1914	766	957	1148
4	25	1456	582	728	874
5	25	699	280	350	419
6	25	1426	570	713	856

Cable No.	Comp. Diameter No. of wire	Cross section area mm ²	Cable capacity mm ²		
			40%	50%	60%
With 23 mm deep sockets					
1	53	5813	2325	2907	3488
2	47	2768	1107	1384	1661
3	43	2909	1164	1455	1745
4	36	1834	734	917	1100
5	30	1444	578	722	866
6	30	1806	722	903	1084

130/72

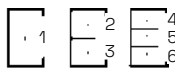

Comp. Diameter No. of wire Cross height section area mm² Cable capacity mm²

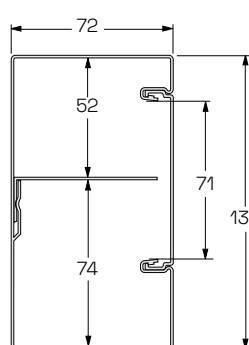

Cable No.	Comp. Diameter No. of wire	Cross height section area mm ²	Cable capacity mm ²		
			40%	50%	60%
Without mounting boxes					
1	57	7687	3075	3844	4612
2	53	3110	1244	1555	1866
3	57	4603	1841	2302	2762
4	41	2218	887	1109	1331
5	34	1691	677	846	1015
6	50	3356	1342	1678	2014
With 50 mm deep sockets					
1	41	5284	2113	2642	3170
2	28	1864	746	932	1118
3	41	3402	1361	1701	2041
4	28	1647	658	823	988
5	18	671	268	335	402
6	41	2936	1170	1463	1755

Cable No.	Comp. Diameter No. of wire	Cross height section area mm ²	Cable capacity mm ²		
			40%	50%	60%
With 45 mm deep sockets					
1	40	5421	2168	2711	3253
2	27	1929	772	965	1158
3	40	3471	1388	1736	2083
4	27	1659	663	829	995
5	23	826	330	413	495
6	40	2888	1155	1444	1733

Cable No.	Comp. Diameter No. of wire	Cross height section area mm ²	Cable capacity mm ²		
			40%	50%	60%
With 23 mm deep sockets					
1	55	7512	3005	3756	4507
2	48	2949	1180	1475	1770
3	52	4515	1806	2258	2709
4	41	2194	878	1097	1316
5	34	1691	677	846	1015
6	50	3205	1282	1603	1923

165V/52

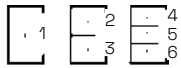

Comp. Diameter No. of wire Cross section area mm² Cable capacity mm² 40% 50% 60%

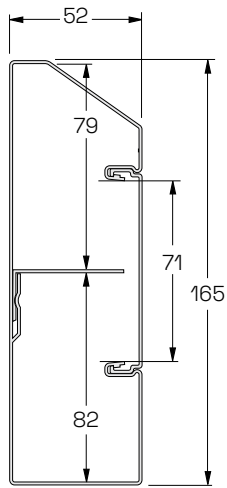

Without mounting boxes					
1	45	7687	3075	3844	4612
2	36	2371	948	1186	1423
3	45	3372	1349	1686	2023
4	30	2236	894	1118	1342
5	27	1156	462	578	694
6	45	37669	15068	18835	22601
With 50 mm deep sockets					
1	45	3836	1534	1918	2302
2	36	1546	618	773	928
3	45	2289	916	1145	1373
4	36	1546	618	773	928
5	0	0	-	-	-
6	45	2289	916	1145	1373
With 45 mm deep sockets					
1	43	3897	1559	1949	2338
2	36	1612	645	806	967
3	43	2270	908	1135	1362
4	36	1152	461	576	691
5	NA	100	40	50	60
6	43	2225	890	1113	1335
With 23 mm deep sockets					
1	40	5945	2378	2973	3567
2	27	2581	1032	1291	1549
3	40	3257	1303	1629	1954
4	27	2022	809	1011	1213
5	24	799	320	400	479
6	40	2586	1034	1293	1552

170/65

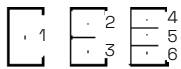

Comp. Diameter No. of wire Cross section area mm² Cable capacity mm² 40% 50% 60%

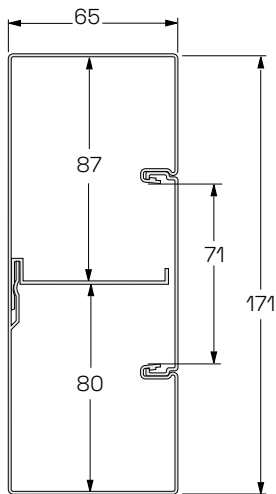

Without mounting boxes					
1	63	9090	3636	4545	5454
2	49	2866	1146	1433	1720
3	63	6013	2405	3007	3608
4	45	2118	847	1059	1271
5	30	1409	564	705	845
6	63	5164	2066	2582	3098
With 50 mm deep sockets					
1	63	6549	2620	3275	3929
2	26	1530	612	765	918
3	63	4917	1967	2459	2950
4	26	1436	574	718	862
5	9	296	118	148	178
6	63	4722	1889	2361	2833
With 45 mm deep sockets					
1	63	6690	2676	3345	4014
2	23	1608	643	804	965
3	63	4967	1987	2484	2980
4	23	1438	575	719	863
5	13	427	171	214	256
6	63	4696	1878	2348	281
With 23 mm deep sockets					
1	63	8756	3502	4378	5254
2	40	2698	1079	1349	1619
3	63	5845	2338	2923	3507
4	40	1951	780	976	1171
5	30	1409	564	705	845
6	63	4998	1999	2499	2999

170A/65

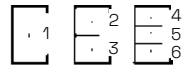

Comp. Diameter No. of wire Cross section area mm² Cable capacity mm² 40% 50% 60%

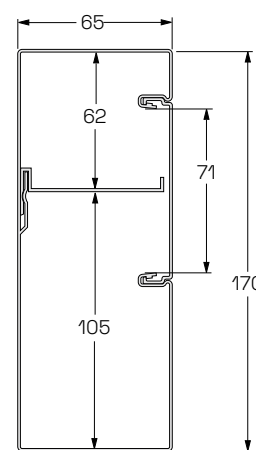

Without mounting boxes					
1	63	9099	3640	4550	5459
2	49	2876	1150	1438	1726
3	63	6015	2406	3008	360
4	41	2019	808	1010	1211
5	30	1420	568	710	852
6	63	5147	2059	2574	3088
With 50 mm deep sockets					
1	63	6124	2450	3062	3674
2	18	1333	533	667	800
3	63	4694	1878	2347	2816
4	18	1221	488	611	733
5	9,5	299	120	150	179
6	63	4494	1798	2247	2696
With 45 mm deep sockets					
1	63	6410	2564	3205	3846
2	18	1481	592	741	889
3	63	4821	1928	2411	2893
4	18	1305	522	653	783
5	13	407	163	204	244
6	63	4566	1822	2278	2734
With 23 mm deep sockets					
1	63	8729	3492	4365	5237
2	40	2686	1074	1343	1612
3	63	5835	2334	2918	3501
4	39	1767	707	884	1060
5	27	1278	511	639	767
6	63	5000	2000	2500	3000

170/72

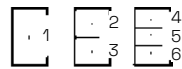

Comp. Diameter No. of wire Cross height section area mm² Cable capacity mm² 40% 50% 60%

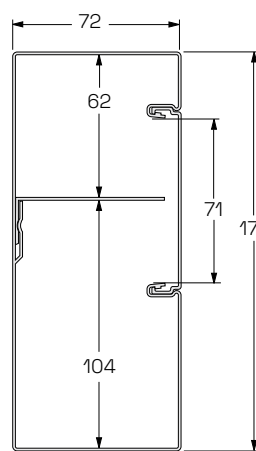

Without mounting boxes					
1	69	10145	4058	5073	6087
2	56	3487	1395	1744	2092
3	69	6491	2596	3246	3895
4	45	2527	1011	1264	1516
5	31	1484	594	742	890
6	69	5500	2200	2750	3300
With 50 mm deep sockets					
1	67	7599	3040	3800	4559
2	33	2278	911	1139	1367
3	67	5270	2108	2635	3162
4	33	1986	794	993	1192
5	15	533	213	267	320
6	67	4936	1974	2468	2962
With 45 mm deep sockets					
1	65	9784	3914	4892	5870
2	47	3307	1323	1654	1984
3	65	6311	2524	3156	3787
4	45	2345	938	1173	1407
5	31	1484	594	742	890
6	65	5320	2128	2660	3192
With 23 mm deep sockets					
1	67	7755	3102	3878	4653
2	30	2352	941	1176	1411
3	67	5337	2135	2669	3202
4	30	1981	792	991	1189
5	20	683	273	342	410
6	67	4907	1963	2454	2944

183/72

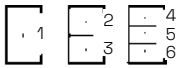

Comp. No.	Diameter of wire	Cross height area mm ²	Cable capacity mm ² section		
			40%	50%	60%

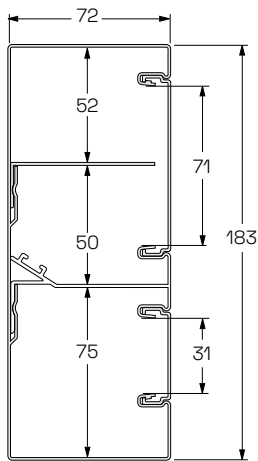

Without mounting boxes					
1	56	5562	2225	2781	3337
2	51	2879	1152	1440	1727
3	40	2477	991	1239	1486
4	34	1932	773	966	1159
5	29	1420	568	710	852
6	29	1449	580	725	869
7	56	742	297	371	445
With 50 mm deep sockets					
1	27	2949	1180	1475	1769
2	27	1672	669	836	1003
3	15	1216	486	608	730
4	27	1395	558	698	837
5	15	484	194	242	290
6	14	879	352	440	527
7	56	742	297	371	445
With 45 mm deep sockets					
1	23	3085	1234	1543	1851
2	23	1733	693	867	1040
3	19	1274	510	637	764
4	23	1390	556	695	834
5	19	606	242	303	364
6	14	853	341	427	512
7	56	742	297	371	445
With 23 mm deep sockets					
1	52	5186	2074	2593	3112
2	46	2690	1076	1345	1614
3	36	2289	916	1145	1373
4	34	1750	700	875	1050
5	29	1420	568	710	852
6	29	1260	504	630	756
7	56	742	297	371	445

233/72

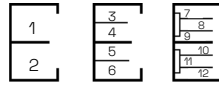

Comp. No.	Diameter of wire	Cross height area mm ²	Cable capacity mm ² section		
			40%	50%	60%

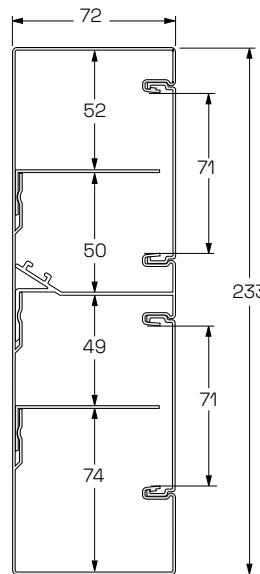

Without mounting boxes					
1	53	5769	2308	2885	3461
2	53	7091	2836	3546	4255
3	51	2918	1167	1459	1751
4	49	2638	1055	1319	1583
5	46	2510	1004	1255	1506
6	57	4363	1745	2182	2618
7	35	1948	779	974	1169
8	30	1437	575	719	862
9	31	1620	648	810	972
10	30	1540	616	770	924
11	30	1437	575	719	862
12	51	3345	1338	1673	2007
With 50 mm deep sockets					
1	28	3203	1281	1602	1922
2	39	4550	1820	2275	2730
3	28	1732	693	866	1039
4	15	1404	562	702	842
5	20	1295	518	648	777
6	39	3185	1274	1593	1911
7	28	1435	574	718	861
8	16	531	212	266	319
9	15	1052	421	526	631
10	20	986	394	493	592
11	16	554	222	277	332
12	39	2816	1126	1408	1690
With 45 mm deep sockets					
1	24	3362	1345	1681	2017
2	37	4629	1852	2315	2777
3	24	1804	722	902	1082
4	21	1473	589	737	884
5	21	1349	540	675	809
6	37	3196	1278	1598	1918
7	24	1430	572	715	858
8	21	674	270	337	404
9	19	1026	410	513	616
10	17	982	393	491	589
11	21	660	264	330	396
12	37	2758	1103	1379	1655
With 23 mm deep sockets					
1	53	5427	2171	2714	3256
2	53	6719	2688	3360	4031
3	47	2743	1097	1372	1646
4	44	2470	988	1235	1482
5	40	2326	930	1163	1396
6	47	4179	1672	2090	2507
7	35	1784	714	892	1070
8	30	1437	575	719	862
9	30	1452	581	726	871
10	30	1356	542	678	814
11	30	1437	575	719	862
12	47	3161	1264	1581	1897

Installation

Steel trunking 110, 120, 130, 170

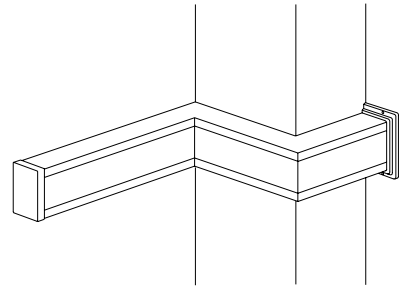

110:	120:	130:	170:
STA550004	INS5551000	STA5550036	INS5553003
INS5550003	STA550023	INS5552003	STA550121
STA550071	INS5551003	STA550103	INS5553013
STA550013	INS5551002		STA550131
INS5550013	STA550090		STA550055
STA550080			INS5553023
			STA550145

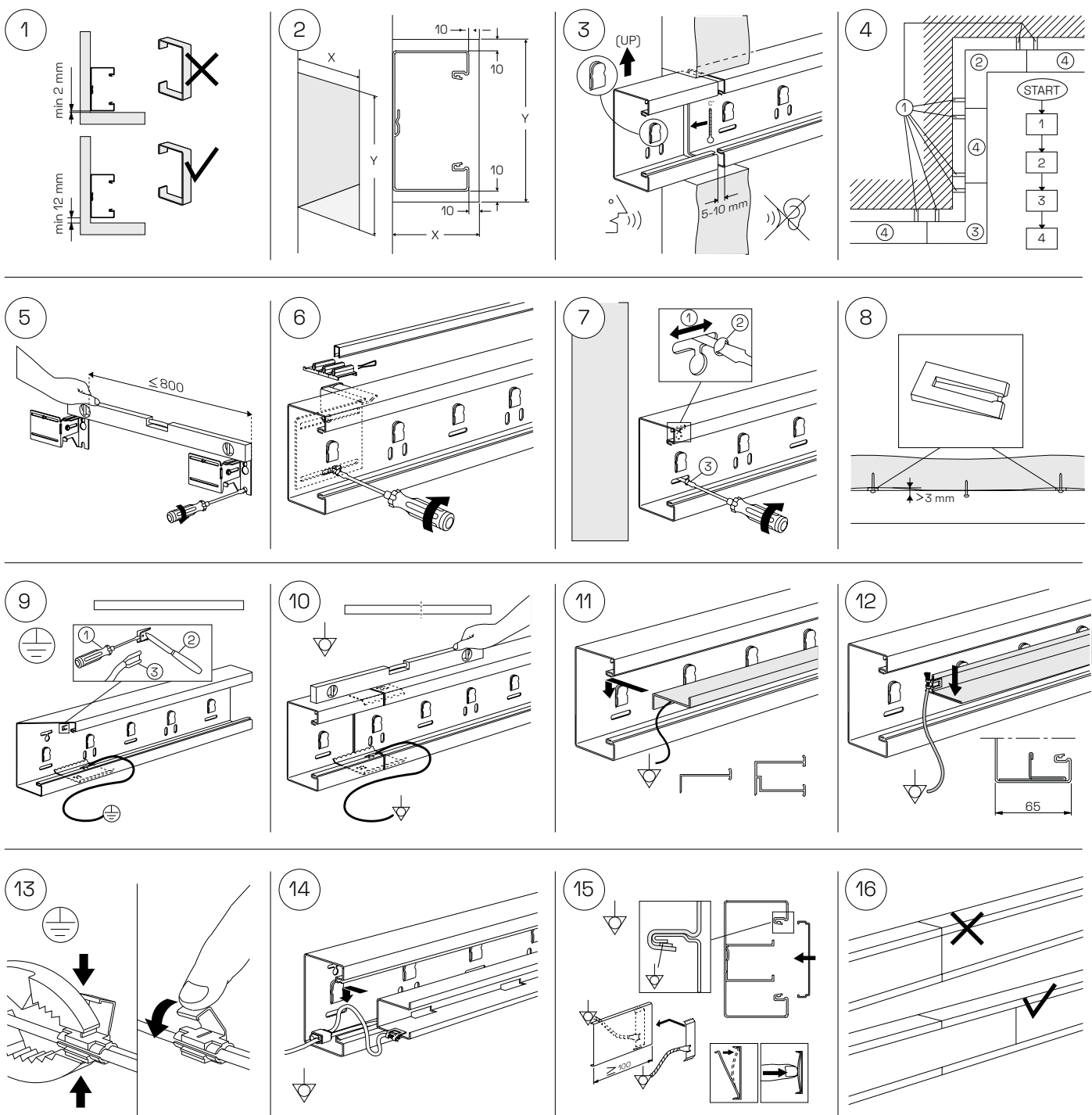

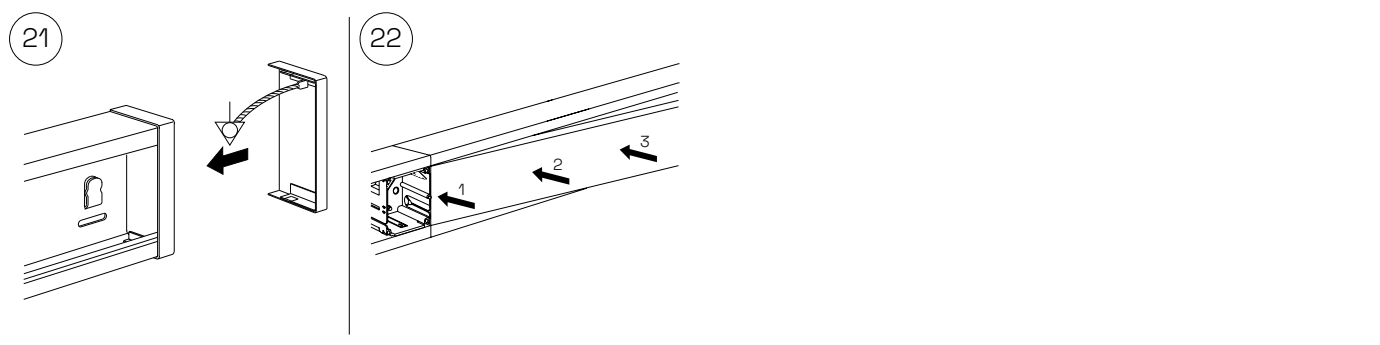
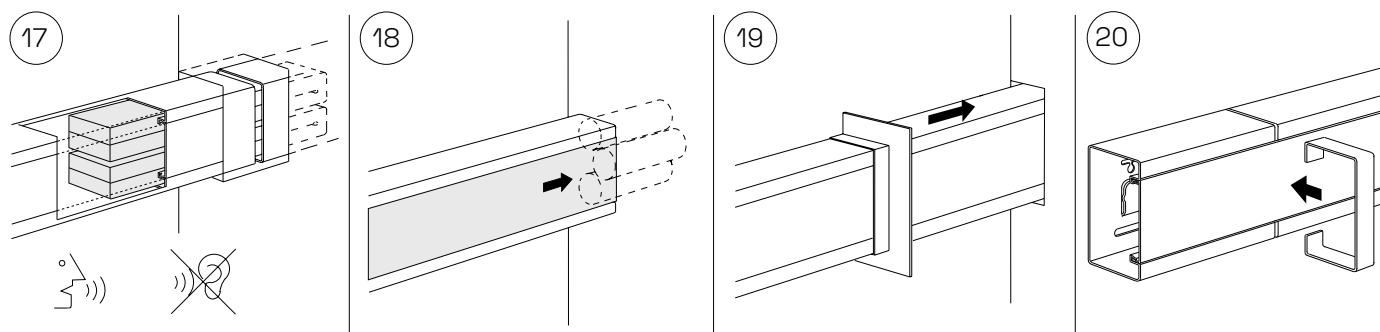

Dismounting

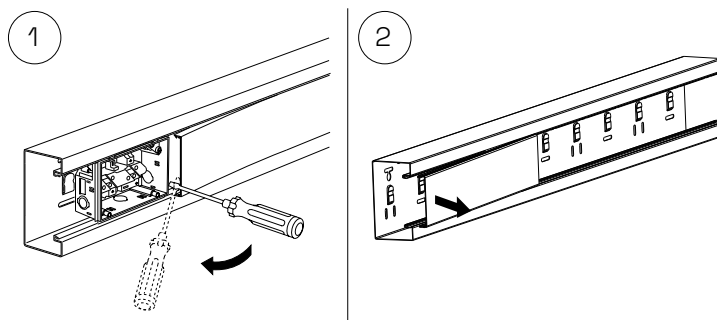

Installation

Steel trunking 165V

STA550045
INS5554003
STA550112

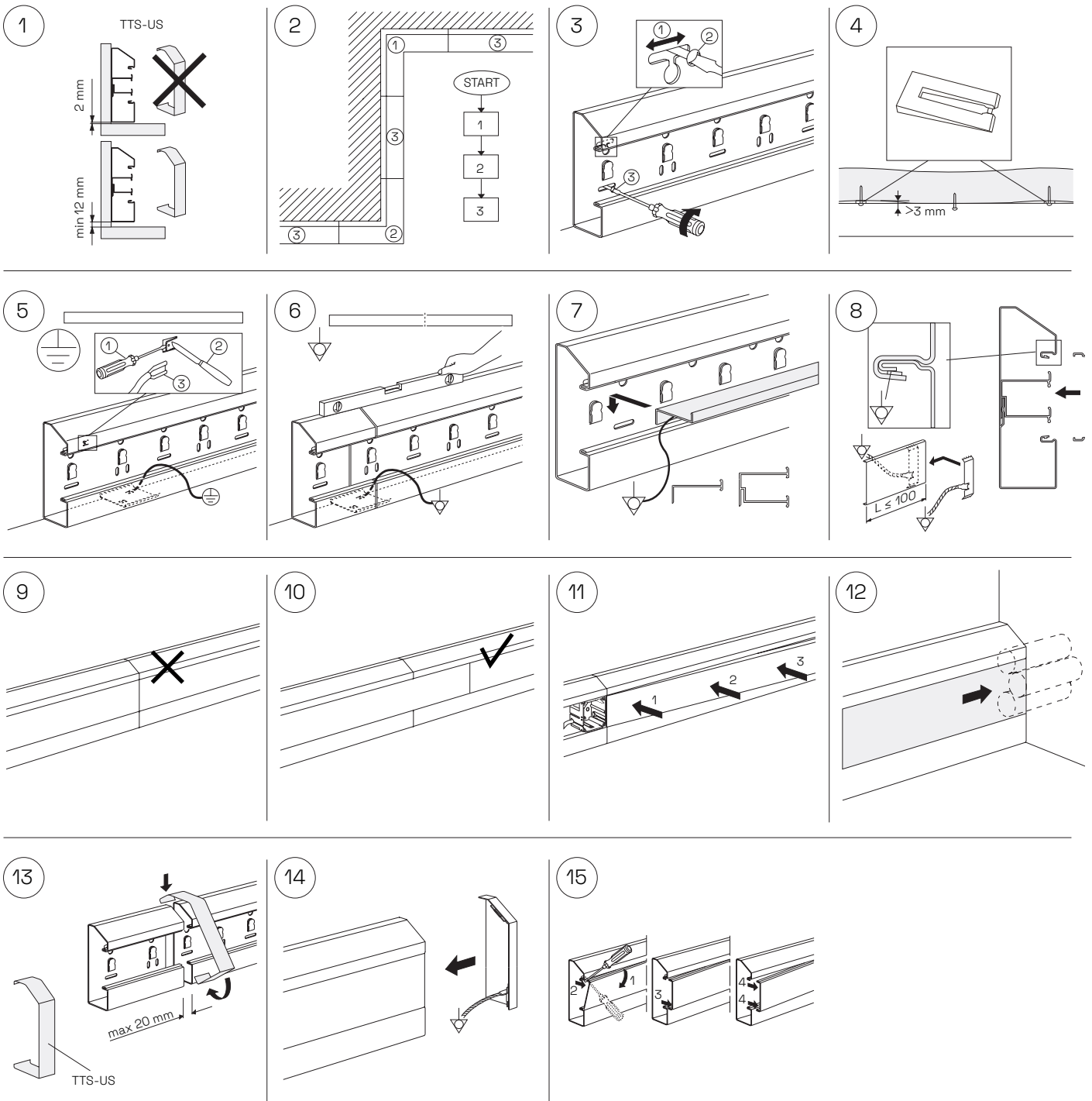
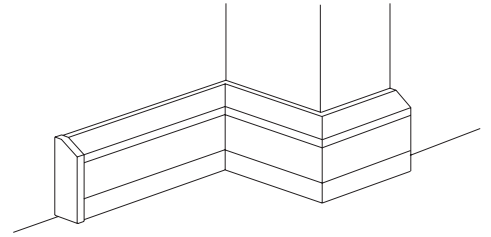

Installation

Steel trunking 183-2, 233-2

INS5555003
INS5558003

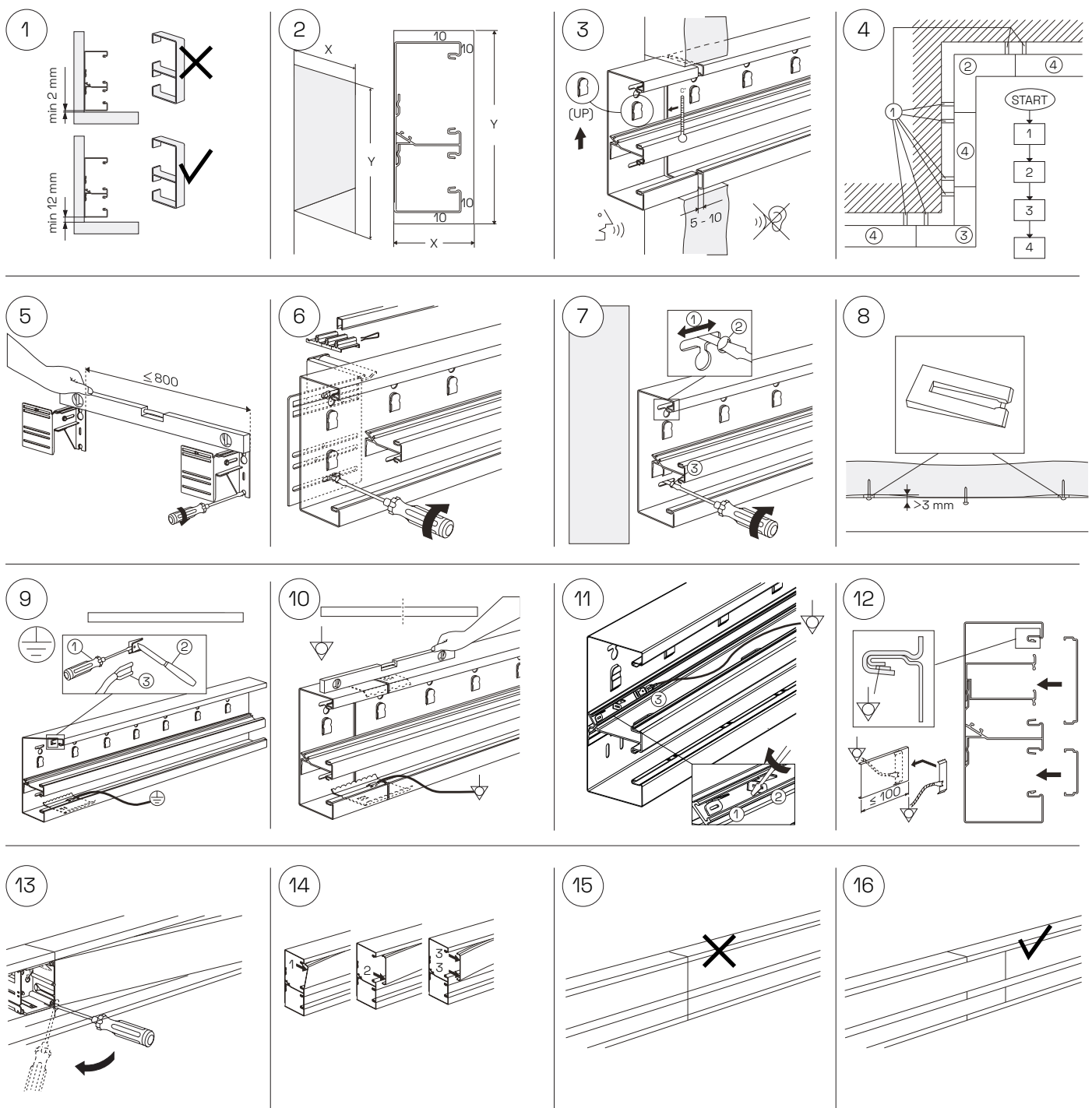
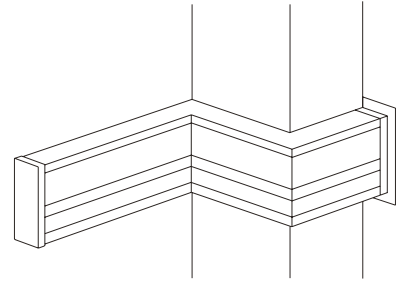

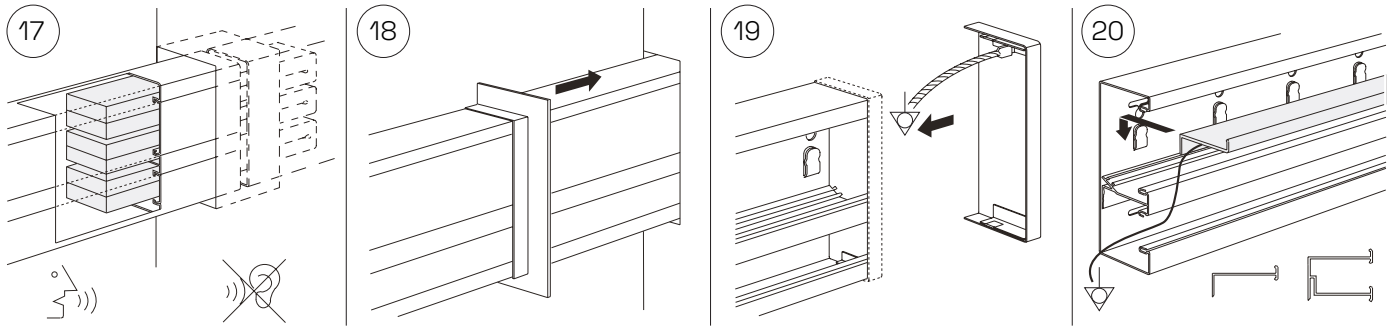

Installation

Universal corners

110:	120:	130:	170:
STA550001	STA550174	STA550031	INS5553109
INS5550103	INS5551105	INS5552123	STA550118
STA550068	STA550020	STA550098	INS5553102
STA550010	INS5551101		STA550138
INS5550123	INS5551104		STA550051
STA550077	STA550087		INS5553123
			STA550141

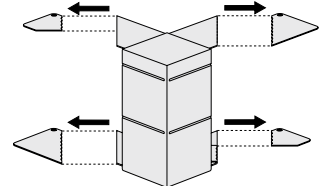
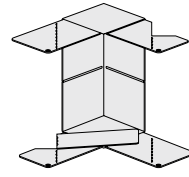

Installation of internal corner

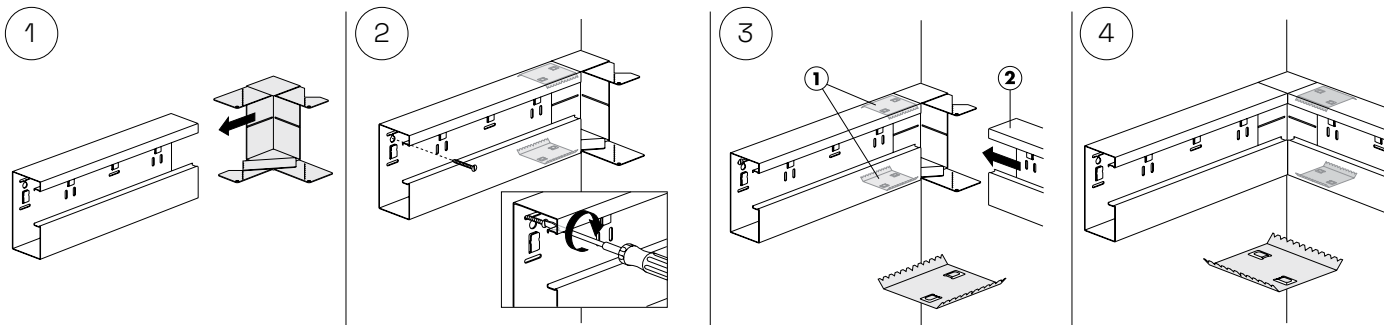
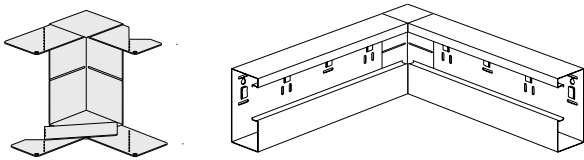

Installation of external corner

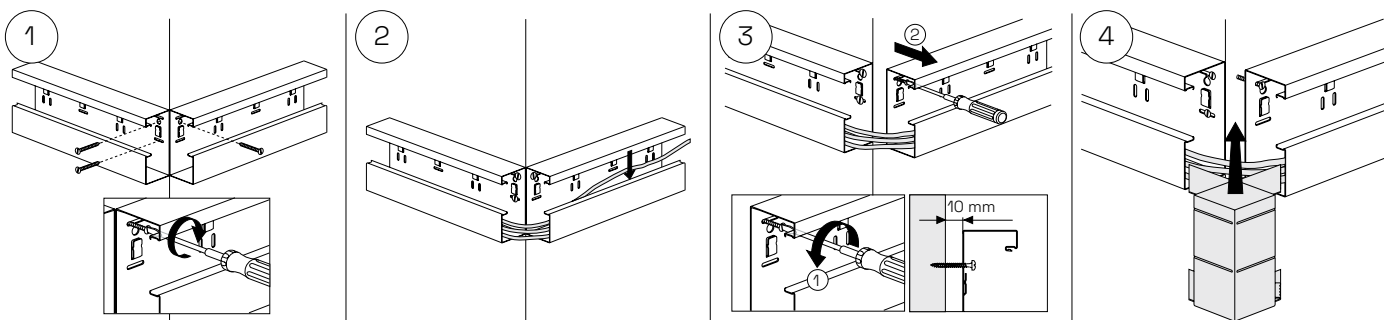
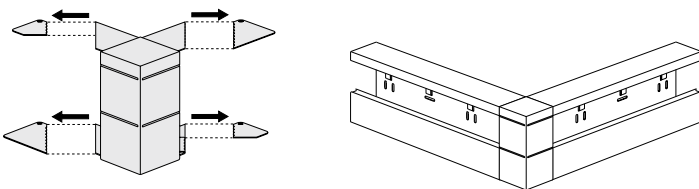

Installation

Universal T-piece

120: STA550172
170: STA550062
STA550019 INS38051774
INS38050074 STA550151
STA550086

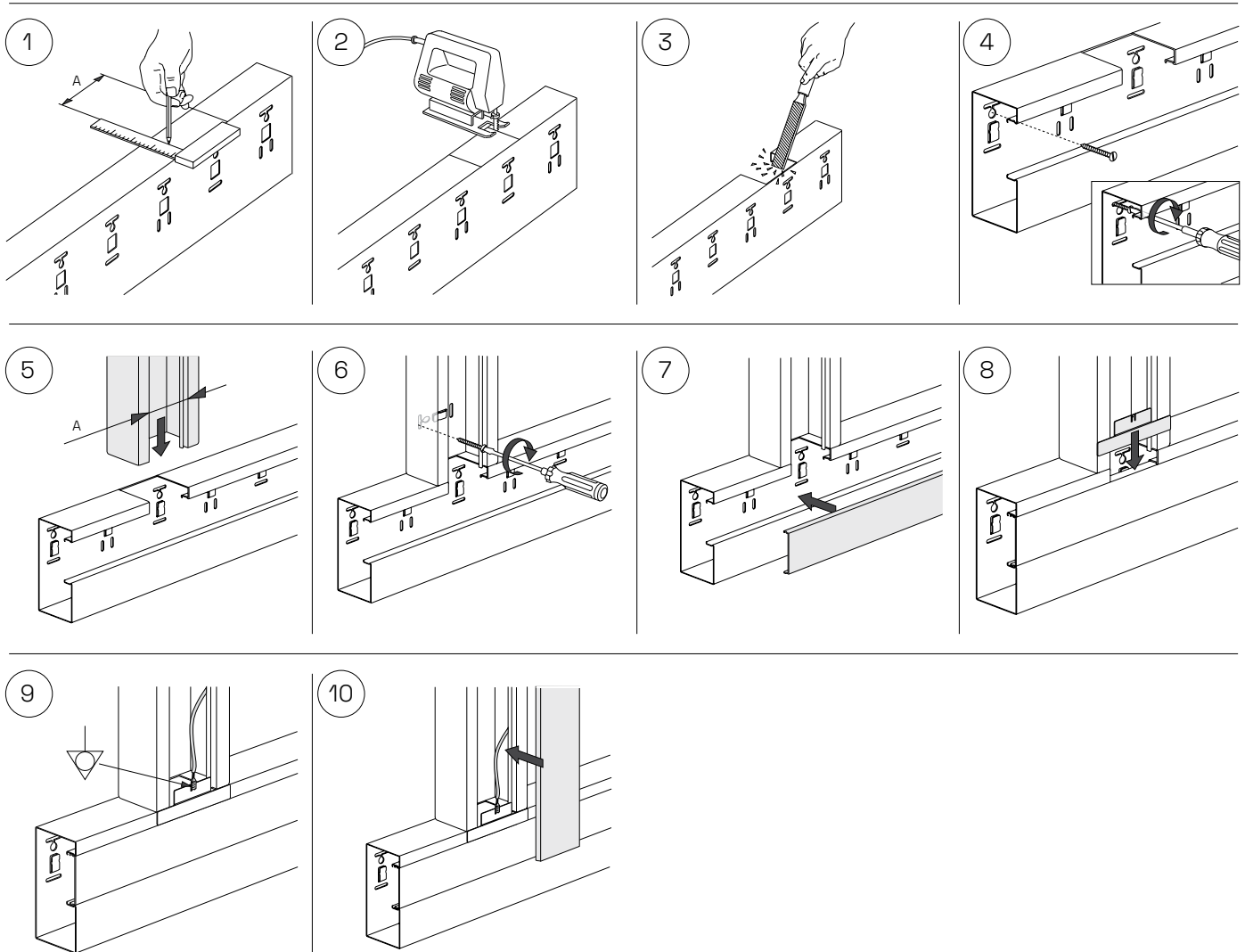
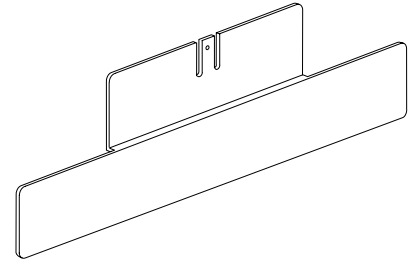

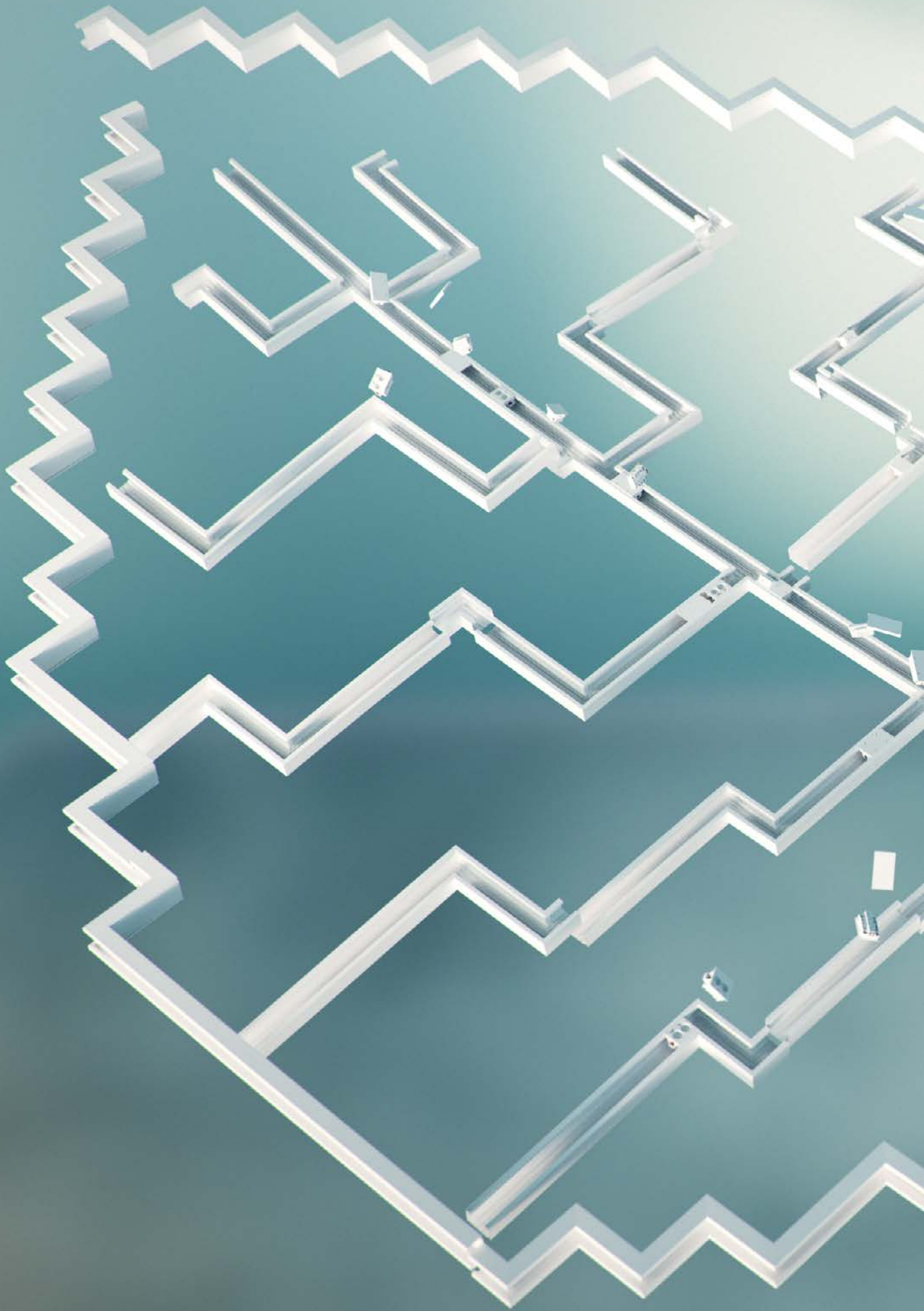

One with nature,
an environmentally
conscious choice

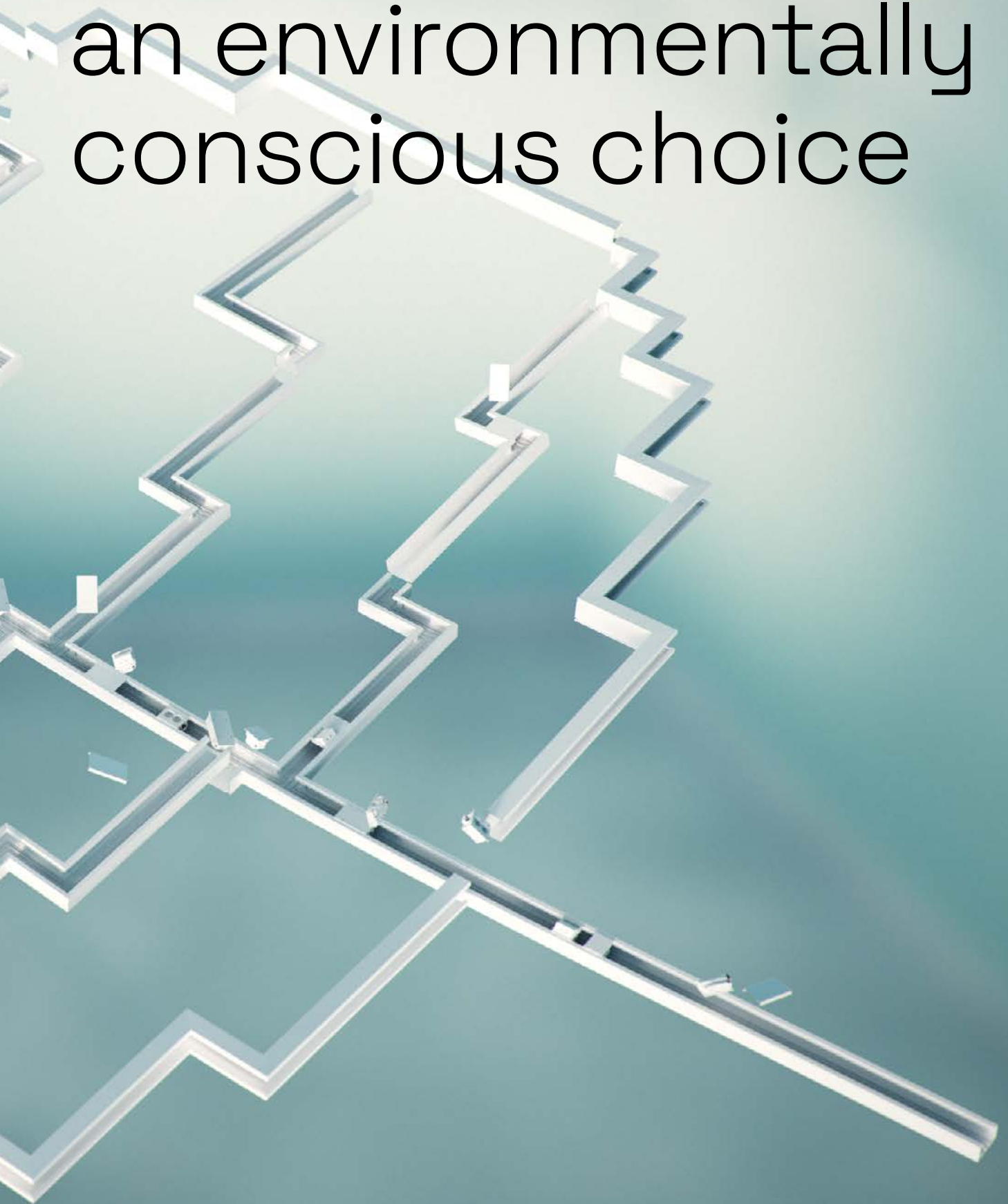

Sustainable solutions for generations to come



Wibe Group is a multinational company with operations in different parts of the world. We influence and with that influence we want to run a responsible business. We do this by understanding and managing all effects in the value chain, in dialogue with our stakeholders. We see it not only as a responsibility but also an opportunity to influence and drive sustainable development for our business and communities.

Our ambition is to take the lead in our industry. We know this is a major challenge, but with a clear vision, long term commitment and a humble approach we will get there.





Dedicated wiring device – smart design, built for ease of use

Our wiring devices are the ideal solution for all your wiring needs, providing a reliable and efficient solution. Our devices have the S-mark from Intertek, which denotes that they meet the safety standards in Europe. They are suitable for use in any commercial building, warehouse, office, school, government building, or hospital. Each part has been designed for a perfect fit, easy to install and to reconfigure.

Safety in mind →

Our wiring devices are designed with safety in mind. The socket outlets are designed to make it impossible to reach the live wires with your fingers, making installation safer. Even if you remove the front cover from the socket outlet, the system remains IP20 safe. Our wiring devices provide double-insulated installation, meaning that no protective earth is required, ensuring reliable and safe performance.

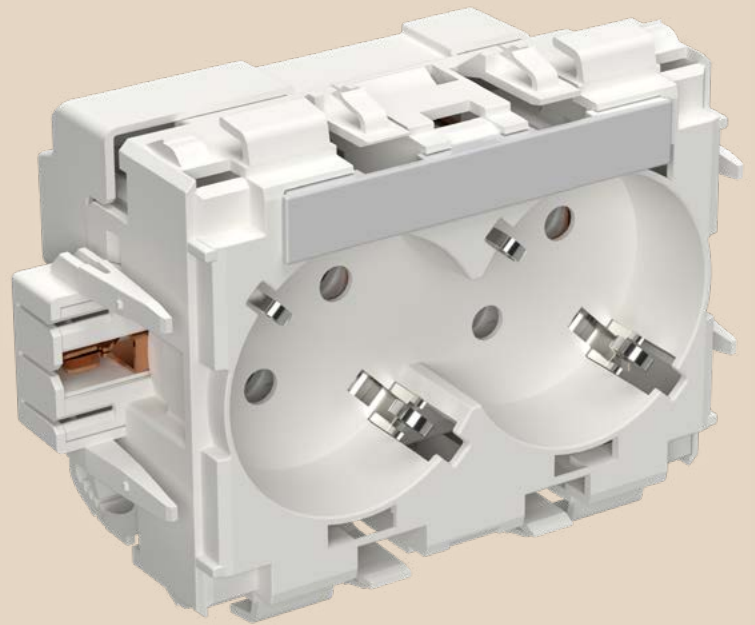

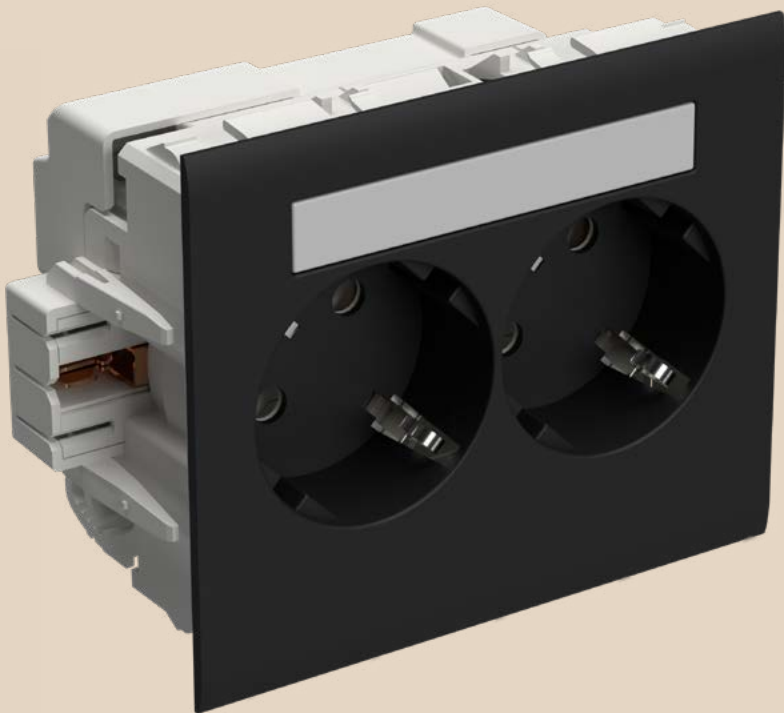

Ease of Use

In addition to safety, our wiring devices are designed for flexibility and functionality. They can easily be mounted and dismantled without having to demount the whole system. Having an optimized number of well-designed and smarter parts means simplifying the procurement, planning and installation process for any building project.



EASY TO MOUNT
AND DISMANTLE
WITH A "CLICK"

Dedicated wiring device

Master socket outlet – direct connect

2 way master socket outlet with direct connect. Intended for installation in installation trunkings with 80 mm front opening. 250V/16A rating. The front cover is installed after the socket is installed in the trunking. This way, the front plate can be replaced if worn or damaged. The front plate locks the socket in the trunking. The terminal block is located on the backside of the socket, and slaves can be installed in two directions. Dimension: 100/84/52 mm. Material: PC, halogen free.



			
Color	White RAL9003	White RAL9010	Black RAL9017
Ref.nr.	STA501000	STA501060	STA501002
EAN Code	7321679003028	7321679003257	7321679003035

Master socket outlet – direct connect without cover

2 way master socket outlet with direct connect and without cover. Socket outlet intended for installation in installation trunkings with 80 mm front opening. 250V/16A rating. The front cover is installed after the socket is installed in the trunking. This way, the front plate can be replaced if worn or damaged. The front plate locks the socket in the trunking. The terminal block is located on the backside of the socket, and slaves can be installed in two directions. Dimension: 100/84/50 mm. Material: PC, halogen free.





	
Color	White RAL9003
Ref.nr.	STA501004
EAN Code	7321679003042

Front cover

Front cover 2-w master. The front cover is installed after the socket is installed in the trunking. Sold as spare part or together with STA501004. For use in trunking with 80 mm front opening. Dimension: 100/84/19 mm. Material: PC, halogen free.



			
Color	White RAL9003	White RAL9010	Black RAL9017
Ref.nr.	STA501015	STA501016	STA501017
EAN Code	7321679003097	7321679003769	7321679003103

Master socket outlet screw connect

Socket outlet 2-way master with screw connect. Socket outlet intended for installation in installation trunkings with 80 mm front opening. 250V/16A rating. The front plate is installed after the socket is installed in the trunking. This way, the front cover can be replaced if worn or damaged. The front plate locks the socket in the trunking. The terminal block is located on the backside of the socket, and slaves can be installed in two directions.

Dimension: 100/84/52 mm.
Material: PC, halogen free.



Color	White RAL9003	White RAL9010	Black RAL9017
Ref.nr.	STA501005	STA501062	STA501007
EAN Code	7321679003059	7321679003806	7321679003066

Slave socket outlet

2 way slave socket outlet. Halogen free. Socket outlet intended for installation in installation trunkings with 80 mm front opening. 250V/16A rating. The front plate is installed after the socket is installed in the trunking. This way, the front cover can be replaced if worn or damaged. The front plate locks the socket in the trunking. The slave socket can be installed in two directions.

Dimension: 100/84/42 mm.
Material: PC, halogen free.



Color	White RAL9003	White RAL9010	Black RAL9017
Ref.nr.	STA501010	STA501063	STA501012
EAN Code	7321679003073	7321679003769	7321679003080

Front cover

Front cover 2-way slave. Halogen free. The front cover is installed after the socket is installed in the trunking. Sold as spare part. For use in trunking with 80 mm front opening.

Dimension: 100/84/19 mm.
Material: PC, halogen free.



Color	White RAL9003	White RAL9010	Black RAL9017
Ref.nr.	STA501024	STA501025	STA501026
EAN Code	7321679003110	7321679003776	7321679003127

Installation box

Single or double installation box. . Installation box when installing C/C 60 sockets/electronics in the trunking. Strain relieves for both cable and 16 mm flexible conduit. Approved for 250V/16A. Light grey.

Material: PC, halogen free.



Ref.nr.	STA501028	STA501029
EAN Code	7321679003134	7321679003141
Dimension	75/84/45 mm	146/84/45 mm

Single installation box lid

Lid for single installation box. Allows to use the installation box as a connection box. The lid is installed with the same screws included in the installation box.

Dimension: 75/84/2 mm.
Material: PC, halogen free.





Color	White RAL9003	White RAL9010	Black RAL9017
Ref.nr.	STA501030	STA501032	STA501034
EAN Code	7321679003158	7321679003783	7321679003172

Double installation box lid

Lid for double installation box. Allows to use the installation box as a connection box. The lid is installed with the same screws included in the installation box.
Dimension: 146/84/2 mm.
Material: PC, halogen free.





			
Color	White RAL9003	White RAL9010	Black RAL9017
Ref.nr.	STA501031	STA501033	STA501035
EAN Code	7321679003165	7321679003790	7321679003189

Data outlet RJ45

Double data outlet RJ45 without RJ45 connector, keystone. RJ 45 data outlet with angled lid. Perfect when installing data jacks in trunking products. Can be positioned horizontally or vertically.
Dimension: 84/84/50 mm.
Material: PC, halogen free.





			
Color	White RAL9003	White RAL9010	Black RAL9017
Ref.nr.	STA501045	STA501066	STA501046
EAN Code	7321679003196	7321679003820	7321679003202

Data outlet RJ45 kit

Double data outlet RJ45, Cat 6, Keystone. RJ45 data outlet with angled lid. Perfect when installing data jacks in trunking products. Can be positioned horizontally or vertically.
Dimension: 84/84/50 mm.
Material: PC, halogen free.





			
Color	White RAL9003	White RAL9010	Black RAL9017
Ref.nr.	STA501050	STA501067	STA501051
EAN Code	7321679003219	7321679003837	7321679003226

Data outlet RJ45 Actassi

RJ45 angled double outlet without RJ45 connector, for Actassi. RJ 45 data outlet with angled lid. Perfect when installing data jacks in trunking products. Can be positioned horizontally or vertically.
Dimension: 84/84/50 mm.
Material: PC, halogen free.



			
Color	White RAL9003	White RAL9010	Black RAL9017
Ref.nr.	STA501055	STA501068	STA501056
EAN Code	7321679003233	7321679003844	7321679003240

Technical data

Rated Current \ Voltage	16 A / 250 V.
Frequency	50Hz
Standards	
"Fixed socket-outlet for Cable Trunking Systems"	IEC 60884-1: 2002+A1+A2
	SS 428 08 34: 2013+T1
	SFS 5610: 2015+A11
	NEK 502: 2016 + A1
Installation box	EN IEC 60670-1: 2021+A1 , LVD (2014/35/EU)
RJ 45 Connector	TIA/EIA-568-C.2-1 Category 6 and ISO 11801 Class E
	"The products comply with the RoHS directive 2011/65 EU, REACH Directive 2006/1907 EU (Restriction of Hazardous Substances) , WEEE Directive 2012/19/EU"
Approvals/Certification	
"Fixed socket-outlet for Cable Trunking Systems"	Intertek Semko AB, Reference No. SE-S-2300298/299, S-Mark
Installation box	Intertek Semko AB, Reference No. SE-S-2300300, S-Mark
RJ 45 Connector, Category 6	 Force Tecnology Test report Nr. 2019-041

Material data

Material	Polycarbonate (PC, Halogen free)
Density	1.2 g/cm ³
Color spec	White RAL9003
	White RAL9010
	Black RAL9017

Operative data

Socket Outlet	
Temperature range	From -25°C to +40°C
Suitable outdoors	No
Degree of protection	IP20
Method of connecting the cable	Rewirable
Type of terminals	Screwless
	Screw-type
Nominal cross-sectional area	2,5 mm ² / For 1,5 mm ² (To be checked the country regulations)
Type of cable	Rigid
RJ45 Connector	
Product description	Unscreened Category 6 RJ45 Characterised up to 250 MHz, 100Ω

Installation

Dedicated wiring device

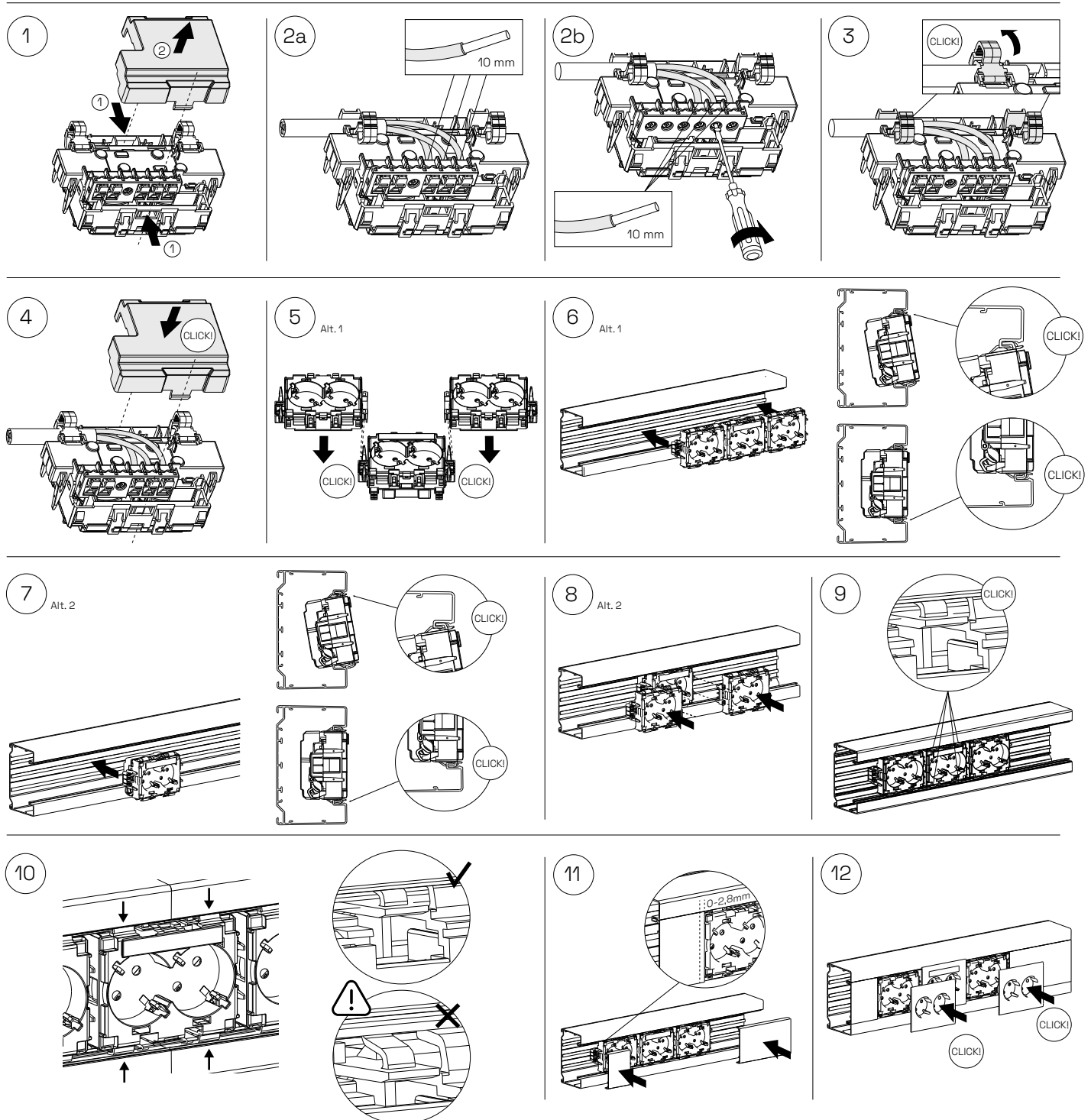
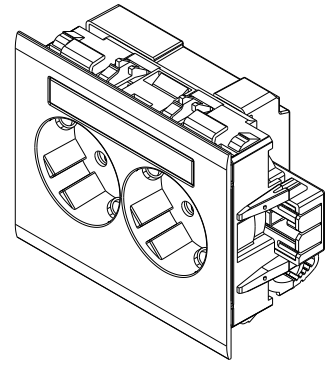

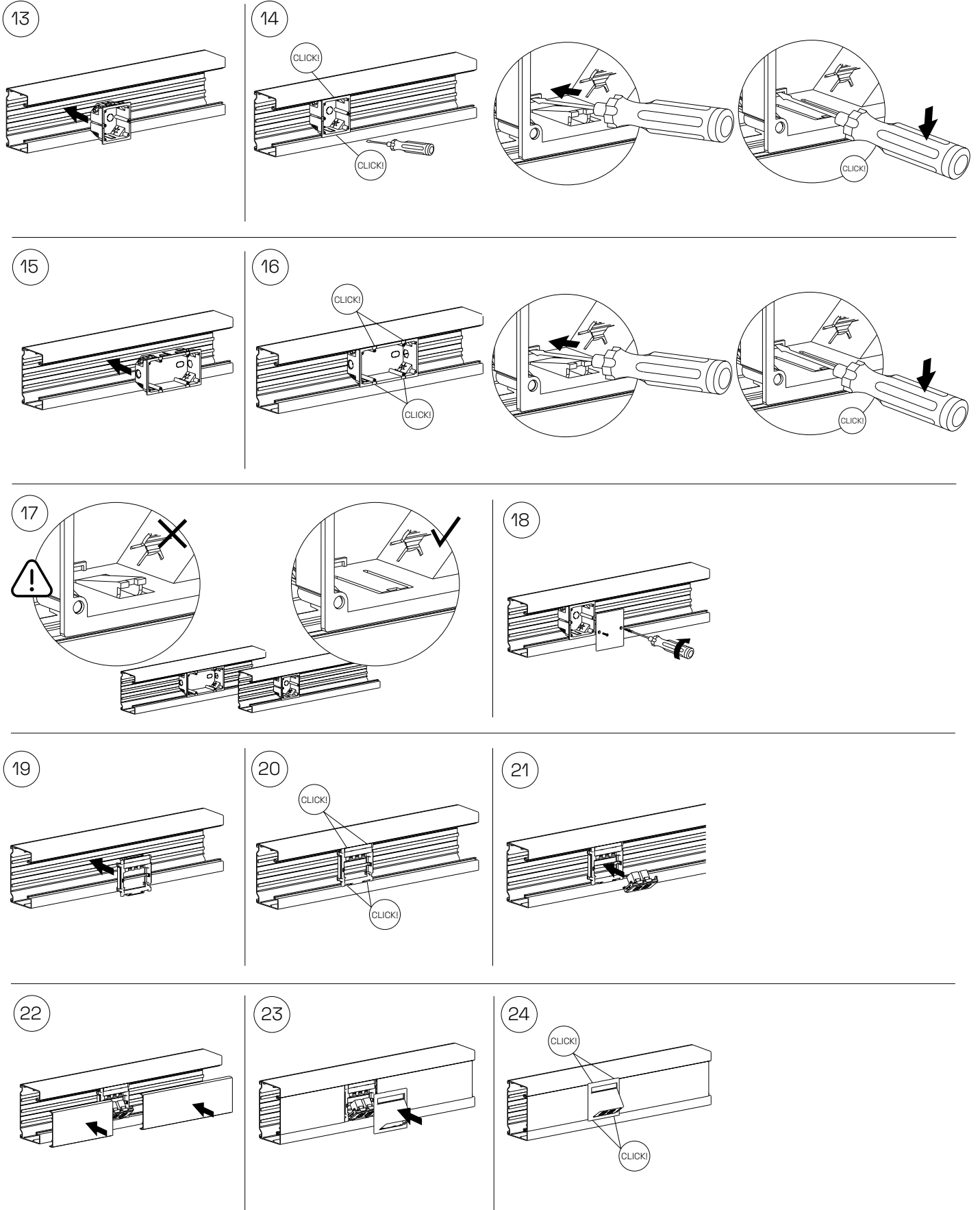

Dismounting

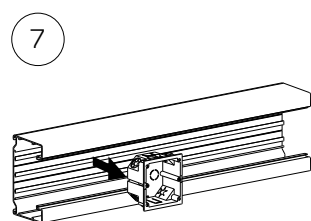
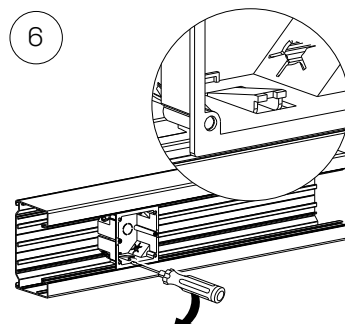
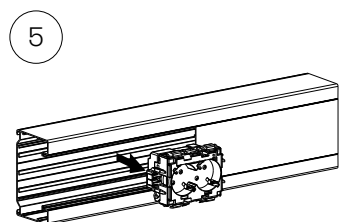
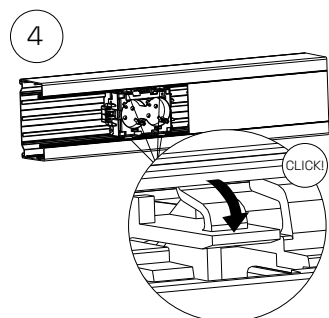
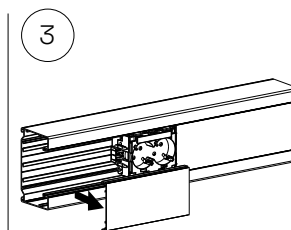
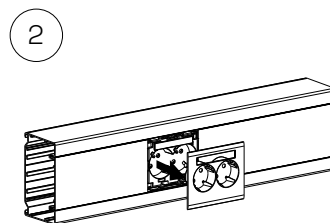
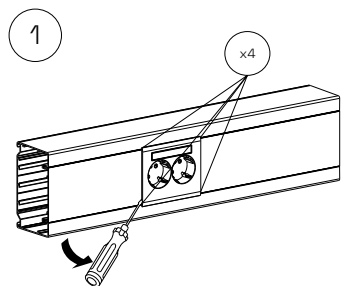

Wiring diagram

3-phase

Reduce the number of feeding cables in larger installations by using a "3-phase bus" with an integrated 5 x 2.5 mm² dual push-in terminal.

1-phase

For small installations, use a 1-phase cable and push in or screw connection.

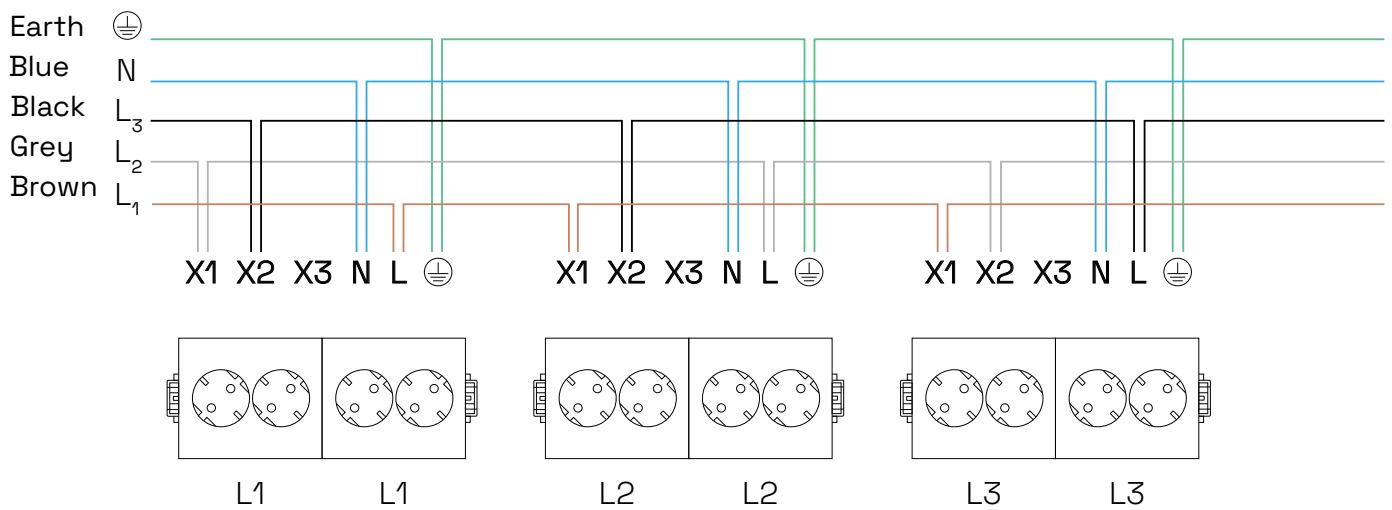

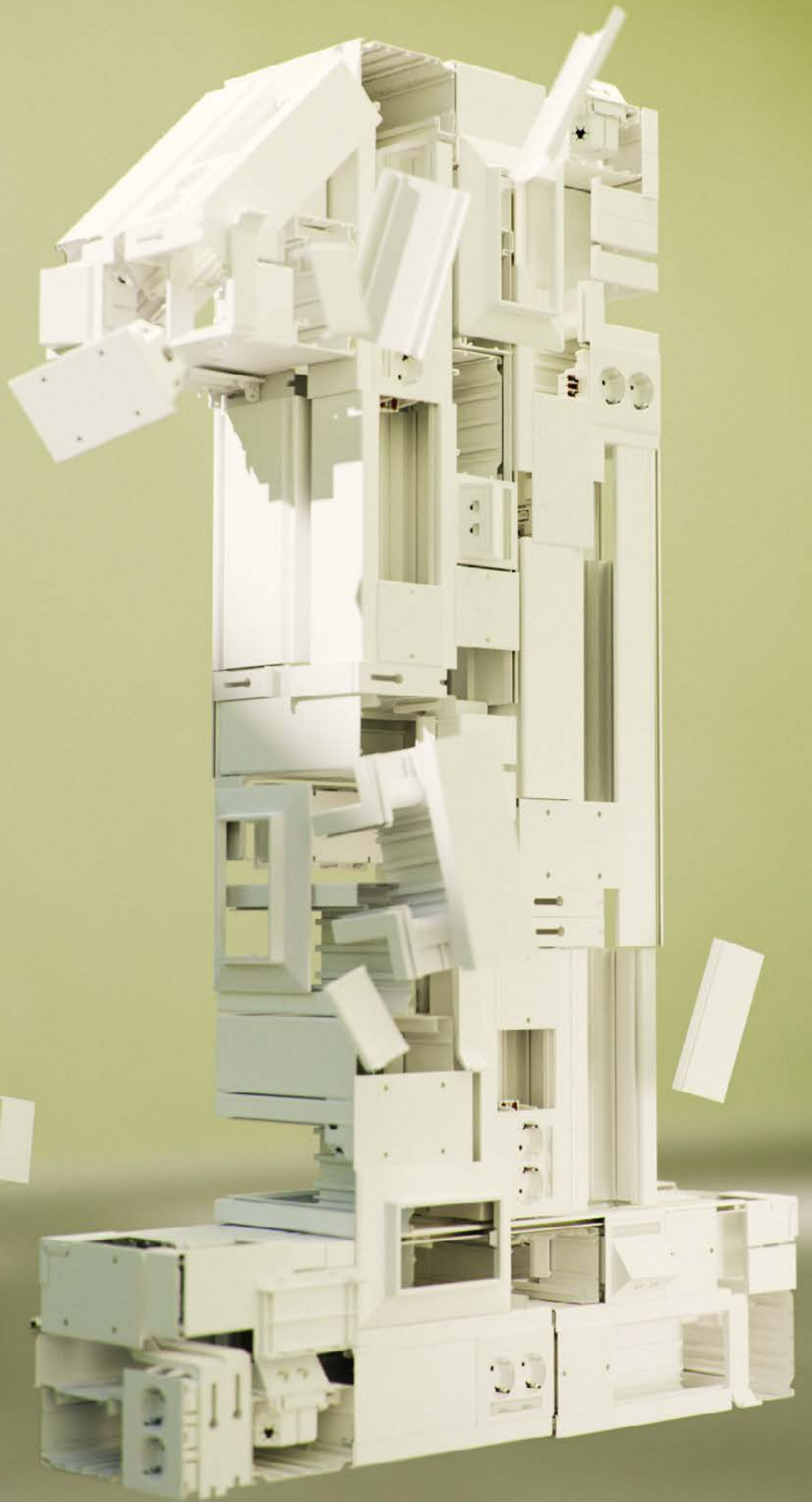

What a
Wonderful
world

